

**CATALOGUE
CATALOGUS
CATALOGUE**

**Architectural
Fire
Places**

(Metalfire)

EEN HAARD ALS DESIGNPRODUCT

De Belgische fabrikant Metalfire ontwerpt en produceert sedert enkele jaren hoogkwalitatieve open en gesloten haarden, en stelt een uniek gamma voor met meer dan 100 verschillende toestellen.

Kenmerkend voor de Metalfire-collectie is het **inspirerende design** welke sinds jaren de gehele markt van open haarden beïnvloedt. Anders dan bij de anderen wordt met de Metalfire-haard ontworpen vanuit een esthetisch verlangen, een streven naar schoonheid, en een voorkeur voor eenheid en rust in de architectuur van de volledige woning en het interieur. De technische kenmerken volgens de **hedendaagse normen** zijn vanzelfsprekend ook aanwezig, maar eerder subtiel zodat zij nooit het uitzicht van de haarden bepalen.

Door de voorliefde voor zuivere details, eenvoud in materialen en een **strakke vormtaal**, brengt Metalfire in de eerste plaats een designproduct, terug te vinden in het uitgebreide standaardgamma en uiteraard in de talloze mogelijkheden in opties en maatwerk. Dit zorgt voor een product dat perfect integreerbaar is in ieder interieur, in iedere wand, en in ieder meubel. Dank zij de veelzijdige mogelijkheden in maatwerk, omlijstingen en verlengingen, krijgt de haardwand de persoonlijke handtekening van de architect of interieurontwerper, subtiel aansluitend bij het ontwerp van het volledige interieur.

LE FOYER, PRODUIT DE DESIGN

Cela fait des années déjà que le fabricant belge Metalfire dessine et produit des foyers ouverts et fermés de toute grande qualité et propose une gamme exceptionnelle de plus de 100 appareils différents.

La collection Metalfire se distingue par l'**inspiration du design** qui influence l'ensemble du marché des foyers ouverts depuis des années. Contrairement aux autres marques, Metalfire conçoit des foyers dérivés d'un pur désir d'esthétique, d'une recherche de la beauté et d'une préférence pour l'homogénéité et la quiétude architecturale de l'ensemble de l'habitation et de l'intérieur. Tout cela **dans le strict respect des normes techniques actuelles** mais avec tant de subtilité que ces aspects austères n'affectent jamais l'apparence extérieure des foyers.

Cet amour des détails purs, la simplicité des matériaux et le **langage épuré** des formes permettent à Metalfire de créer avant tout des produits de design intégrés à une vaste gamme standard et de proposer de nombreuses possibilités d'options et de travail sur mesure. Il en émerge des produits parfaitement intégrables dans tout type d'intérieur, de paroi ou de mobilier. Grâce à ces multiples possibilités de personnalisation des dimensions, des cadres et des prolongements, le foyer porte la griffe de l'architecte ou de l'architecte d'intérieur et s'intègre subtilement à la conception de l'intérieur dans son ensemble.

A FIREPLACE AS A DESIGN PRODUCT

The Belgian manufacturer Metalfire has designed and produced high-quality open and closed fireplaces for a number of years, and presents a unique range comprising more than 100 different models.

The Metalfire collection is characterized by its **inspiring design** that has influenced the entire market of open fireplaces. Different to the others, the Metalfire fireplaces are designed from an aesthetical view, and strive for beauty, and have an inclination for unity and quiet in the architecture of the entire house and its interior. The technical features **according to contemporary standards** are also present, however they are understated so that they never overwhelm the appearance of the fireplaces.

Because of the predilection for pure details, simplicity of materials, and minimalism, Metalfire brings a **design product** in first instance, evidenced in the extensive standard range, and of course found in the numerous possibilities with regard to options and made-to-measure. This ensures a product that can be perfectly integrated in any interior, in any wall and in any piece of furniture. Thanks to the broad possibilities in custom work, finishing frames and extensions, the fireplace wall bears the architect's or interior designer's personal signature, finely in tune with the design of the entire interior.

Metalfire

Metalfire

Metalfire

HOUT BOIS WOOD

4 ULTIME D

houtgestookte liftdeurhaarden
foyers escamotables au bois
wood-burning fireplaces with sliding door

kamerluchtonafhankelijk – primaire/secundaire/tertiaire verbrandingslucht
indépendant de l'air ambiant – apport d'air primaire/secundaire/tertiaire
room air-independent – primary/secondary/tertiary air supply

18 UNIVERSAL

CUSTOM MADE

houtgestookte haarden met opschuifbaar vonkenscherm
foyers au bois avec pare-étincelles escamotable
wood-burning fireplaces with liftable firescreen



recognise the original

GAS GAZ GAS

40 AVENUE^{plus} / AVENUE

gesloten gashaarden met hoog rendement
foyers fermés au gaz à haut rendement
gas high efficiency closed fireplaces

68 URBAN

CUSTOM MADE

gasgestookte open haarden
foyers ouverts au gaz
gas-burning open fireplaces

EXTRA

CUSTOM MADE

92 MAATWERK SUR-MESURE MADE-TO-MEASURE

94 METALFORMS

96 ANEMONE

97 FIRE GRID

97 FIRE GRID GAS

100 COMPANY

104 MATERIALS



Ultime D MF 1050-75 WHE 1S
Concept made to measure
(horizontal extension + plinth)

MODERNE TECHNIEKEN IN EEN ZUIVERE VORM

Deze generatie kamerlucht onafhankelijke houtgestookte liftdeurhaarden is voorzien van een dynamische verbrandingstechniek die een optimale verbranding verzekert en een hoog rendement. De toestellen zijn kamerlucht-onafhankelijk en bijgevolg geschikt voor alle woningen welke worden gebouwd volgens de nieuwste bouwvoorschriften. Een typisch Metalfire product dus, voorzien van de meest vooruitstrevende techniek.

DES TECHNIQUES MODERNES DANS UNE FORME PURE

Cette génération de foyers indépendant de l'air ambiant à bois à porte coulissante se base sur une technique de combustion dynamique assurant une combustion optimale et un rendement supérieur. Les appareils sont indépendants de l'air ambiant et conviennent donc pour tout type d'habitation construite selon les toutes dernières normes en matière de construction. Les produits typiques de Metalfire sont donc agrémentés de la technique la plus avancée.

MODERN TECHNIQUES IN A PURE FORM

This generation of room air-independent wood-burning fireplaces with sliding door is equipped with a dynamic combustion technology, which ensures an optimum combustion and a high efficiency. The appliance operates independently from ambient air, and therefore is suitable for all houses that will be built according to the latest building regulations. Hence, a typical Metalfire product equipped with the most sophisticated techniques.



ULTIME D (DYNAMIC COMBUSTION)

HOUTGESTOOKTE LIFTDEURHAARDEN

FOYERS ESCAMOTABLES AU BOIS

WOOD-BURNING FIREPLACES WITH SLIDING DOOR











Ultime D MF 1050-75 WHE 1S
Concept made to measure
(4-sided finishing frame + horizontal extension)



Ultime D MF 800-75 WHE 1S
Concept made to measure
(3-sided finishing frame + horizontal extension)





Ultime D MF 1050-75 WHE 1S
Concept made to measure
(3-sided finishing frame + horizontal extension + plinth)



AFMETINGEN | DIMENSIONS | DIMENSIONS

FRONT

ULTIME D MF 600-50 WHE 1S

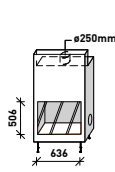

Vermogen/Puissance/Power: 8 – 13,8kW
 Rendement/Rendement/
 Efficiency: 80%**
 CO-uitstoot/rejet de CO/
 CO-emission: 0,09%
 uitstoot fijn stof/émission de poussières/
 micro-dust emission: 33 mg/Nm³



ULTIME D MF 600-75 WHE 1S

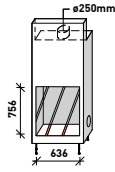

Vermogen/Puissance/Power: 12 – 18,8kW
 Rendement/Rendement/
 Efficiency: 80%**
 CO-uitstoot/rejet de CO/
 CO-emission: 0,07%
 uitstoot fijn stof/émission de poussières/
 micro-dust emission: 20 mg/Nm³



ULTIME D MF 800-50 WHE 1S

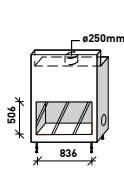

Vermogen/Puissance/Power: 10 – 16,6kW
 Rendement/Rendement/
 Efficiency: 80%**
 CO-uitstoot/rejet de CO/
 CO-emission: 0,07%
 uitstoot fijn stof/émission de poussières/
 micro-dust emission: 32 mg/Nm³



ULTIME D MF 800-75 WHE 1S

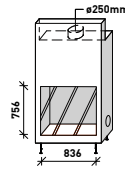

Vermogen/Puissance/Power: 14 – 21,2kW
 Rendement/Rendement/
 Efficiency: 80%**
 CO-uitstoot/rejet de CO/
 CO-emission: 0,08%
 uitstoot fijn stof/émission de poussières/
 micro-dust emission: 30 mg/Nm³



ULTIME D MF 1050-50 WHE 1S

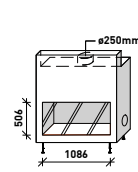

Vermogen/Puissance/Power: 15 – 19,4kW
 Rendement/Rendement/
 Efficiency: 80%**
 CO-uitstoot/rejet de CO/
 CO-emission: 0,06%
 uitstoot fijn stof/émission de poussières/
 micro-dust emission: 30 mg/Nm³



ULTIME D MF 1050-75 WHE 1S

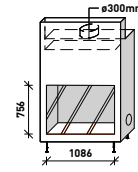

Vermogen/Puissance/Power: 15 – 23,5kW
 Rendement/Rendement/
 Efficiency: 81%**
 CO-uitstoot/rejet de CO/
 CO-emission: 0,08%
 uitstoot fijn stof/émission de poussières/
 micro-dust emission: 40 mg/Nm³



2 SIDES OPEN L/R

ULTIME D MF 800-50 WHE 2S V20 L/R

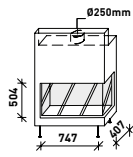

Vermogen/Puissance/Power: 16,1kW
 Rendement/Rendement/
 Efficiency: 82%**
 CO-uitstoot/rejet de CO/
 CO-emission: 0,061%
 uitstoot fijn stof/émission de poussières/
 micro-dust emission: 24 mg/Nm³



ULTIME D MF 1050-50 WHE 2S V20 L/R

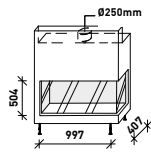

Vermogen/Puissance/Power: 19,8kW
 Rendement/Rendement/
 Efficiency: 84%**
 CO-uitstoot/rejet de CO/
 CO-emission: 0,072%
 uitstoot fijn stof/émission de poussières/
 micro-dust emission: 30 mg/Nm³



3 SIDES OPEN

ULTIME D MF 800-50 WHE 3S V20

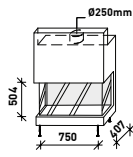

Vermogen/Puissance/Power: 16,1kW
 Rendement/Rendement/
 Efficiency: 82%**
 CO-uitstoot/rejet de CO/
 CO-emission: 0,061%
 uitstoot fijn stof/émission de poussières/
 micro-dust emission: 24 mg/Nm³



ULTIME D MF 1050-50 WHE 3S V20

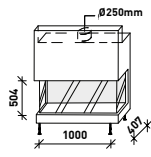

Vermogen/Puissance/Power: 19,8kW
 Rendement/Rendement/
 Efficiency: 84%**
 CO-uitstoot/rejet de CO/
 CO-emission: 0,072%
 uitstoot fijn stof/émission de poussières/
 micro-dust emission: 30 mg/Nm³



ULTIME C

ULTIME C MF 1300-50 WHE 1S

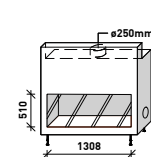

• Classic combustion
 niet-kamerlucht-
 onafhankelijk
 non étanche
 non room air-independent

Vermogen/Puissance/Power: 19-27kW
 Rendement/Rendement/
 Efficiency: 78%**
 CO-uitstoot/rejet de CO/
 CO-emission: 0,10%
 uitstoot fijn stof/émission de poussières/
 micro-dust emission: 26 mg/Nm³



* nominaal vermogen
 puissance nominale
 nominal power
 ** rendement bij
 nominaal vermogen
 rendement selon
 puissance nominale
 efficiency at rated power

Alle tekeningen van de Metalfire haarden zijn te downloaden als PDF, DWG, BIM, STEP (3D) op www.metalfire.eu
 Tous les dessins des foyers Metalfire peuvent être téléchargés en PDF, en DWG, BIM en STEP (3D) sur www.metalfire.eu
 All drawings of the Metalfire fireplaces can be downloaded as a PDF, DWG, BIM, STEP (3D) file on www.metalfire.eu.

OPTIES | OPTIONS | OPTIONS

FINISHING
FRAMES

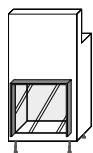

3-SIDED
FINISHING FRAME

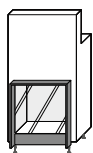

3-SIDED
FINISHING FRAME + PLINTH

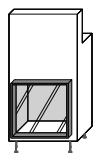

4-SIDED
FINISHING FRAME

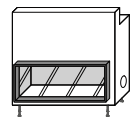

4-SIDED
FINISHING FRAME

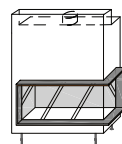

6-SIDED
FINISHING FRAME

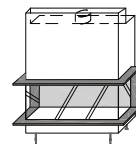

8-SIDED
FINISHING FRAME

Concepten en kaders zijn ook in **MAATWERK** verkrijgbaar: zie p. 92
 Concepts et cadres également disponibles en **SUR-MESURE**: voyez p. 92
 Concepts and frames also available in **MADE-TO-MEASURE**: see p. 92

CONCEPTS

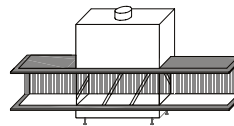
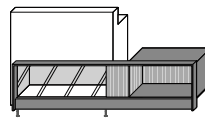
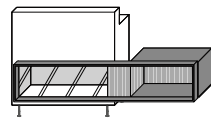
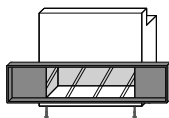
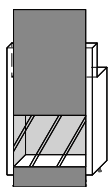

...

CUSTOM MADE

BINNENAFWERKING FINITION INTÉRIEURE INTERIOR FINISH

ORIGINAL



Verticaal geribde gietijzeren lamellen (20mm)
 Lamelles verticales striées en fonte (20mm)
 Vertical ribbed cast iron (20mm)
 See p.112

ROUND



Verticaal afgeronde gietijzeren lamellen (20mm)
 Lames en fonte arrondies verticalement (20mm)
 Vertically rounded cast iron (20mm)
 See p.114

TRIANGLE



Verticaal gekartelde gietijzeren lamellen (20mm)
 Lames en fonte dentelées verticalement (20 mm)
 Vertically serrated cast iron (20mm)
 See p.115



VOORZIENINGEN | APPROVISIONNEMENTS | SUPPLIES

- 1 aanvoer verse lucht (onder of achter aan te sluiten)
apport d'air frais (à raccorder en dessous ou derrière)
fresh air supply (to be connected at the bottom or back)
- 2 aanvoer kamerlucht/convectielucht
apport d'air ambiant/air de convection
ambient air/convection air supply
- 3 primaire luchttoevoer/verbrandingslucht
apport d'air primaire/air de combustion
primary air supply/combustion air
- 4 secundaire luchttoevoer/luchtspoeling voor glas
apport d'air secondaire/balayage d'air pour la vitre
secondary air supply/air swipe for glass
- 5 tertiaire luchttoevoer/naverbranding •
apport d'air tertiaire/post-combustion •
tertiary air supply/after-combustion •
- 6 afvoer rookgassen
évacuation des gaz de combustion
flue gass outlet
- 7 uitstoot verwarmde convectielucht
évacuation d'air chaud (air de convection)
outlet for heated convection air

KENMERKEN | CARACTÉRISTIQUES | FEATURES

- A geïsoleerde stookruimte met ORIGINAL afwerking (verticaal geribde gietijzeren lamellen)
chambre de combustion isolée à finition ORIGINAL (lamelles verticales striées en fonte)
insulated combustion chamber with ORIGINAL finishing (vertical ribbed cast iron)
- B stookbodem in vlak staal 10 mm met aslade en gietijzeren stookrooster
sole foyer en acier de 10 mm avec cendrier et grille en fonte
10 mm flat steel firing bottom plate with ash drawer and cast-iron firing grid
- C regeling voor luchttoevoer (primaire, secundaire en tertiaire luchttoevoer)
régulation de l'apport d'air (primaire, secondaire et tertiaire)
air supply control (primary, secondary and tertiary air supply)
- D rookafremplaten in RVS, verstelbaar
déflecteurs en inox, ajustable
stainless steel flue gas baffle plates, adjustable
- E geleiding voor convectielucht doorheen de convectiekast
conduits de l'air de convection à travers le manteau de convection
convection air guide through convection jacket
- F optionele afwerkingslijst in massief staal (dikte 10 mm)
en option, cadre de finition en acier massif (épaisseur 10mm)
optional finishing frame made of solid steel (10 mm thick)

- **ULTIME C 1300-50 WHE 1S:**
geen tertiaire luchttoevoer
sans apport d'air tertiaire
no tertiary air supply

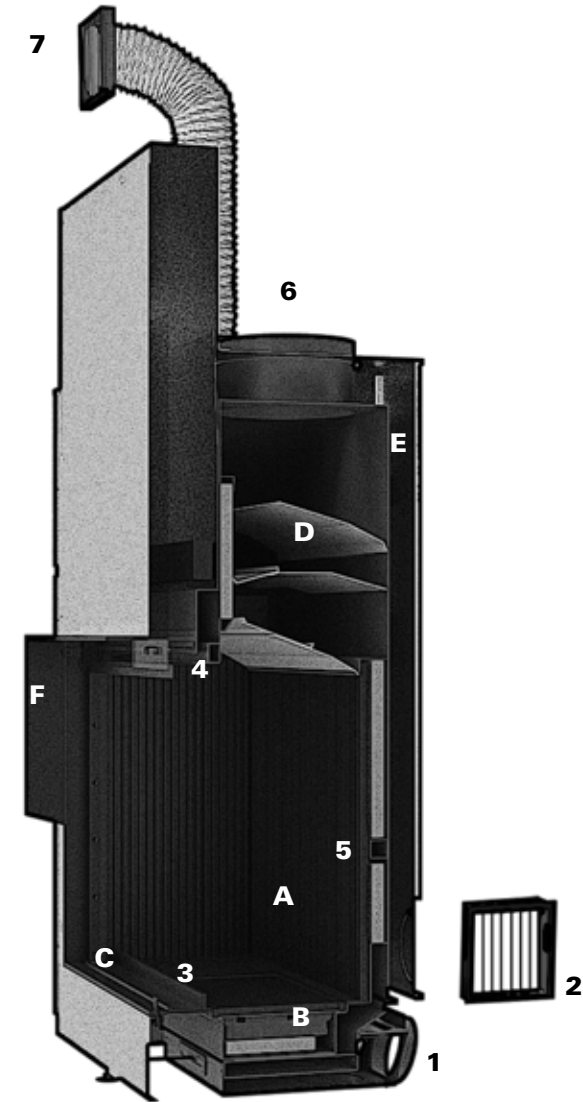

Universal MF 1050-60 W 1S (made to measure)
Concept made to measure with firegrid
(3-sided finishing frame + horizontal extension + floor plate)

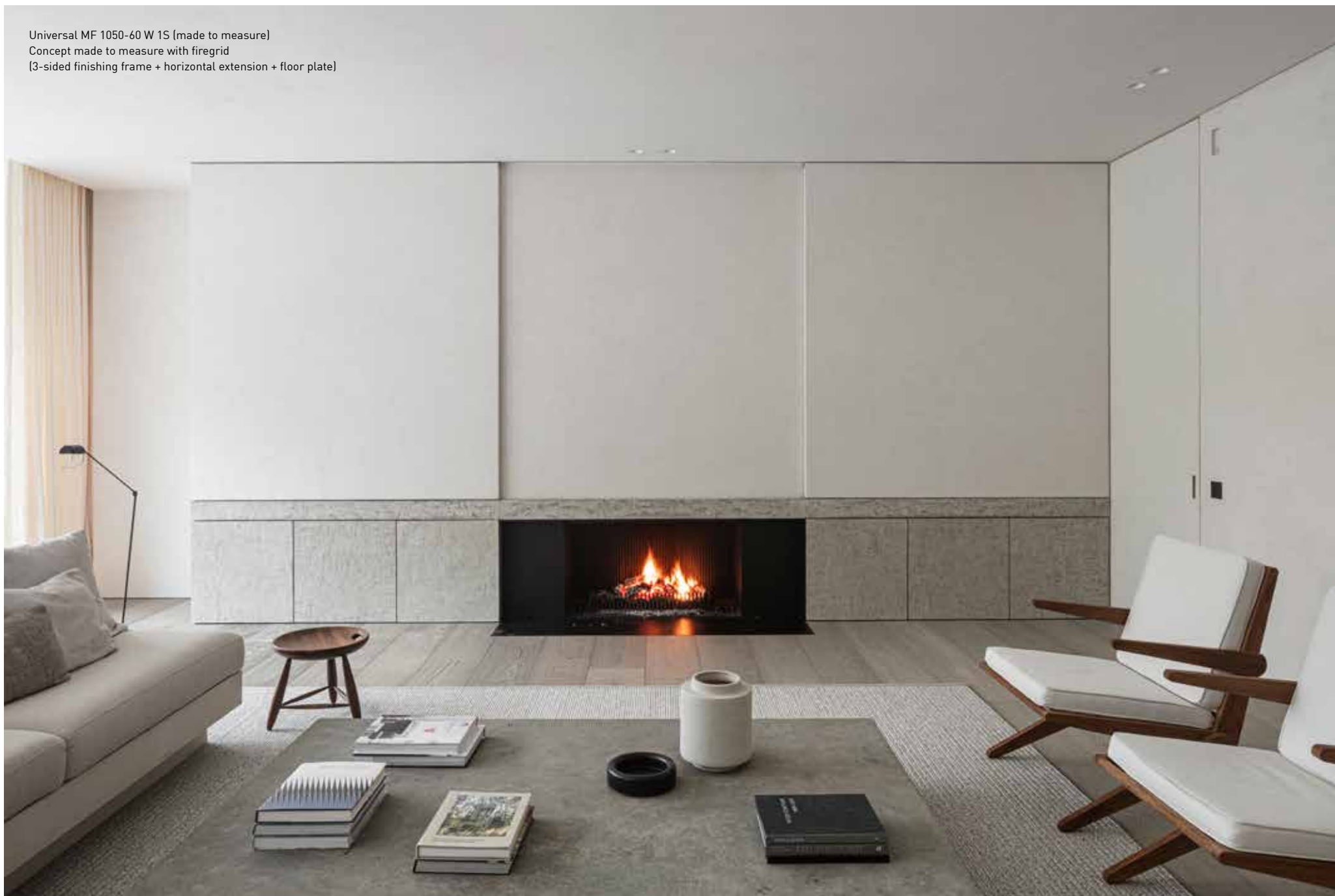

CUSTOM MADE

UNIVERSAL

HOUTGESTOOKTE HAARDEN MET OPSCHUIFBAAR VONKENSCHERM
FOYERS AU BOIS AVEC PARE-ÉTINCELLES ESCAMOTABLE
WOOD-BURNING FIREPLACES WITH LIFTABLE FIRESCREEN



DE KUNST VAN HET MINIMALISME

Deze traditionele houtgestookte haarden worden gekozen omwille van de esthetische impact in de ruimte, de grote afmetingen, de minimalistische opbouw van de onderdelen, en de mogelijkheid deze volledig op maat te laten maken. Dit brengt eindeloze mogelijkheden in afmeting, stijl en afwerking. Naast de verticale gietijzeren geribde Metalfire® lamellen (ORIGINAL), is er ook een uitvoering in massieve stalen lamellen van 10 mm dikte, in een willekeurige samenstelling van verschillende breedtes (DESIGN) beschikbaar. Het opschuifbare vonkenscherm in fijn metaalgaas, het stookrooster en uitneembare aslade, de afsluitbare rookgas- en luchtklep en de keuze in binnenafwerking maken de UNIVERSAL-haard als equivalent voor de haarden in metselwerk, tot een veiliger en esthetischer alternatief. Voor woningen gebouwd volgens de nieuwste bouwvoorschriften, zijn een bijkomende rookgasventilator en elektrisch gestuurde afsluitbare kleppen beschikbaar, die deze combinatie perfect mogelijk en veilig maken.

L'ART DU MINIMALISME

Ces foyers traditionnels à bois sont appréciés pour leur impact esthétique sur l'espace, pour leurs grandes dimensions et la conception minimaliste de leurs composants, sans oublier la possibilité de tout faire réaliser sur mesure. Vous disposez donc de possibilités infinies de dimensions, de styles et de finition. Outre les traditionnelles lamelles striées verticales en fonte Metalfire® (ORIGINAL), il y a aussi une version des lamelles en acier massif de 10 mm d'épaisseur, en composition arbitraire de diverses largeurs (DESIGN) disponible. Le pare-feu coulissant en fin treillis métallique, la grille de combustion et le bac à cendres escamotable, le clapet réglable d'aération et le clapet d'évacuation des gaz de combustion ainsi que le choix de la finition intérieure élèvent le foyer UNIVERSAL à la hauteur des foyers en maçonnerie et propose une alternative offrant davantage de sécurité et d'esthétique. Pour des bâtiments neufs, construits selon les plus nouvelles normes, il y a plusieurs options disponibles, comme des ventilateurs de gaz de fumées, des clapets d'aération et clapets de gaz de fumées à fermeture électrique,...

THE ART OF MINIMALISM

These traditional wood-burning fireplaces are chosen because of the aesthetical impact in the room, the large dimensions, the minimalistic construction of the components, and the possibility to have it fully made to measure. This results in endless possibilities in size, style and finish. In addition to the Metalfire® cast iron ribs (ORIGINAL), there is a construction comprising solid 10 mm thick steel streaks in a random assembly of different widths (DESIGN) available. The sliding spark screen in fine metal mesh, the fire grate and removable ashpan, the flue gas and air valve which can be closed, and the choice with regard to interior finish make the UNIVERSAL fireplace, as an equivalent of the masonry fireplaces, a safer and more aesthetical alternative. For new houses, built according to the latest building regulations, different options are available, e.g. mechanical flue gas fans, electric flue gas valves, electric air supply valves, ...



Universal MF 1300-75 W 1S
Concept made to measure
(3-sided finishing frame + horizontal extension + floor plate)





Universal MF W 3S EXT room divider
(made to measure)



Universal MF W 3S EXT
room divider (made to measure)







Universal MF 1300-75 W 1S
(made to measure)
Concept made to measure
(conical frame + floor plate)







Universal MF 1900-75 W 1S (made to measure)
Concept made to measure
(3-sided finishing frame + horizontal extension + floor plate)



Universal MF 740-75 W BBQ (made to measure)
Concept made to measure
(4-sided finishing frame + horizontal extension)







Universal MF 740-75 W BBQ
(3-sided finishing frame + vertical extension)





Universal MF 1050-75 W 1S
Concept made to measure
(horizontal extension)



Universal MF 800 -75 W 1S - Concept made to measure
(3-sided finishing frame + horizontal extension + floor plate)





FRONT

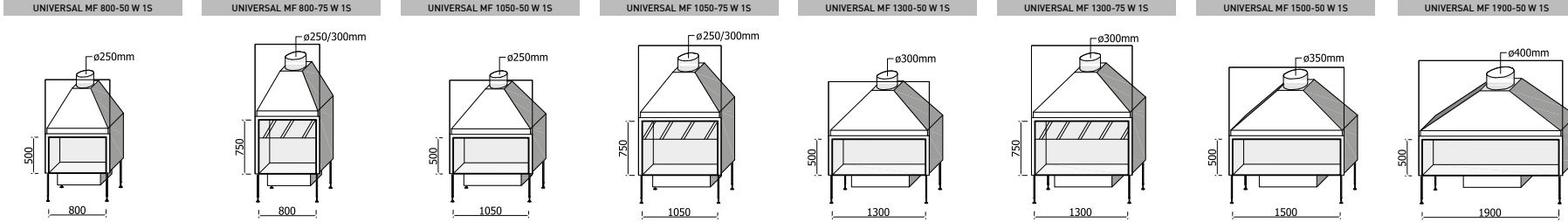

2 SIDES OPEN L/R

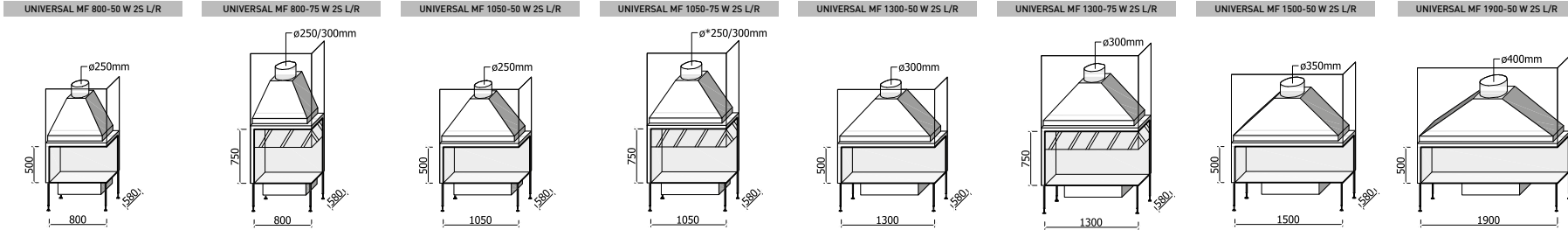

TUNNEL

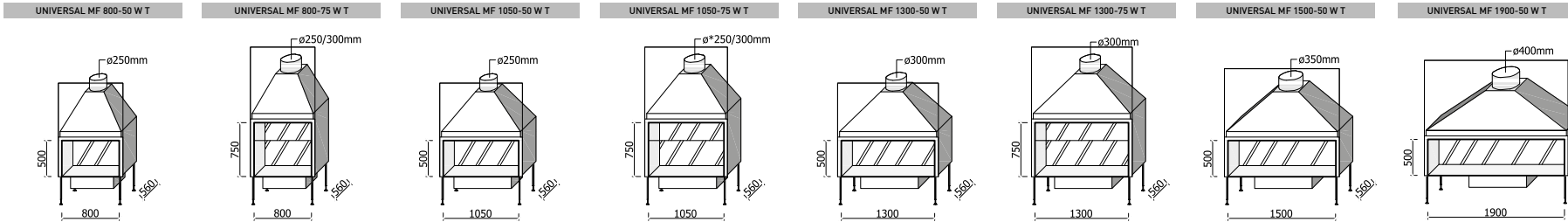

3 SIDES OPEN

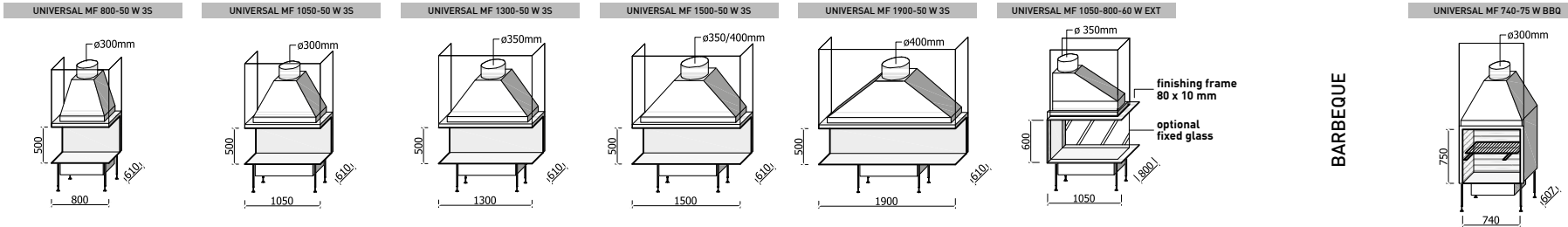

BARBEQUE

- Onderdelen kunnen ook los besteld worden
- Possibilité de commander séparément les pièces
- Spare parts can also be ordered separately.

CUSTOM MADE

- Haarden op maat zijn mogelijk
- Possible foyers sur mesure
- Custom-made fireplaces are possible

- Alle tekeningen van de Metalfire haarden zijn te downloaden als PDF, DWG, STEP (3D) op www.metalfire.eu
- Tous les dessins des foyers Metalfire peuvent être téléchargés en PDF, en DWG, STEP (3D) sur www.metalfire.eu
- All drawings of the Metalfire fireplaces can be downloaded as a PDF, DWG, STEP (3D) file on www.metalfire.eu

OPTIES | OPTIONS | OPTIONS

FINISHING FRAMES

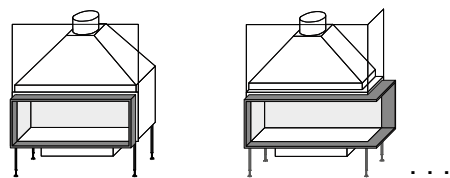

CONCEPTS

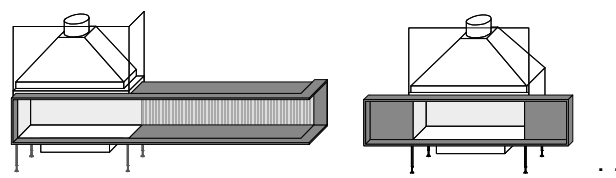

CONVECTION JACKET

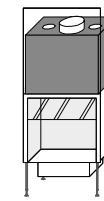

ONDERDELEN | COMPOSANTS | PARTS

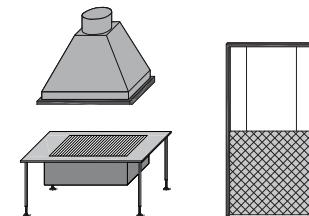

CUSTOM MADE

Concepten en kaders zijn ook in **MAATWERK** verkrijgbaar: zie p. 92 | Concepts et cadres également disponibles en **SUR-MESURE**: voyez p. 92 | Concepts and frames also available in **MADE-TO-MEASURE**: see p. 92

BINNENAFWERKING FINITION INTÉRIEURE INTERIOR FINISH

ORIGINAL



See p.112

Verticaal geribde gietijzeren lamellen (20mm)
Lamelles verticales striées en fonte (20mm)
Vertical ribbed cast iron (20mm)

DESIGN



See p.113

Asymmetrische stalen lamellen (10mm)
Lamelles asymétriques en acier (10mm)
Asymmetrical steel streaks (10mm)

ROUND

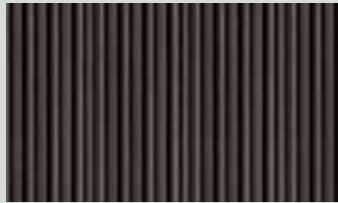

See p.114

Verticaal afgeronde gietijzeren lamellen (20mm)
Lames en fonte arrondies verticalement (20mm)
Vertically rounded cast iron (20mm)

TRIANGLE



See p.115

Verticaal gekartelde gietijzeren lamellen (20mm)
Lames en fonte dentelées verticalement (20 mm)
Vertically serrated cast iron (20mm)

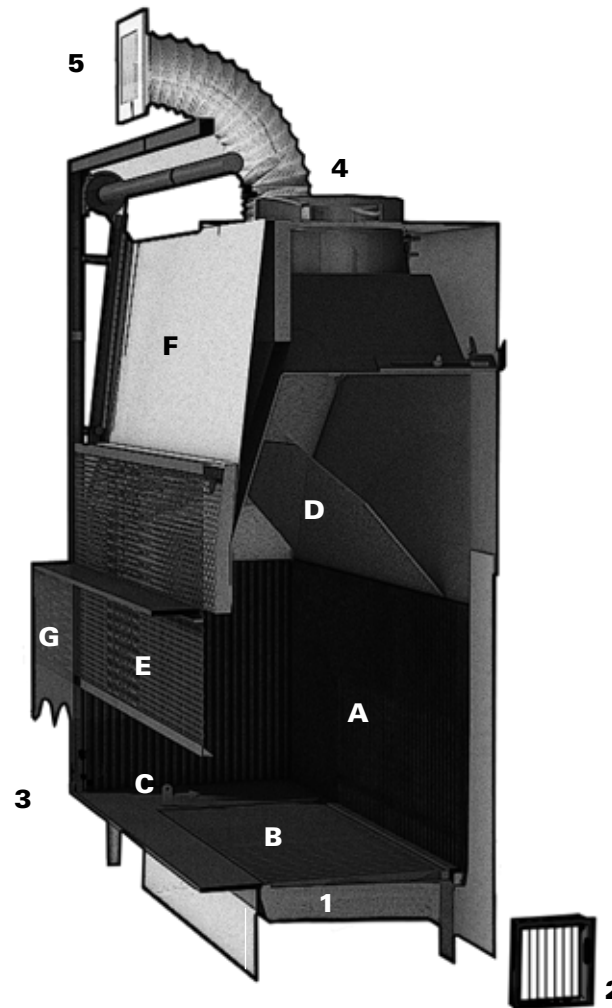

VOORZIENINGEN | APPROVISIONNEMENTS | SUPPLIES

- 1 aanvoer verse lucht
apport d'air frais
fresh air supply
- 2 aanvoer kamerlucht/convectielucht
apport d'air ambiant/air de convection
ambient air/convective air supply
- 3 primaire luchttoevoer/verbrandingslucht
apport d'air primaire/air de combustion
primary air supply/combustion air
- 4 afvoer rookgassen
évacuation des gaz de combustion
flue gas outlet
- 5 uitstoot verwarmde convectielucht/recuperatiewarmte
évacuation d'air chaud (air de convection)/ air de récupération
outlet for heated convection air

KENMERKEN | CARACTÉRISTIQUES | FEATURES

- A stookruimte met ORIGINAL afwerking (verticaal geribde gietijzeren lamellen), ook DESIGN, ROUND & TRIANGLE afwerking verkrijgbaar
chambre de combustion à finition ORIGINAL (lamelles verticales striées en fonte), finition DESIGN, ROUND & TRIANGLE aussi disponible
combustion chamber with ORIGINAL finishing (vertical ribbed cast iron), DESIGN, ROUND & TRIANGLE finishing also available
- B* stookbodem in vlak staal 10 mm met aslade en gietijzeren stookrooster
sole foyère en acier de 10 mm avec cendrier et grille en fonte
10 mm flat steel firing bottom plate with ash drawer and cast-iron firing grid
- C manueel te bedienen hendel voor afsluiten rookgasklep en beluchtungskleppen
poignées à ouverture manuelle pour le réglage du clapet des gaz de combustion et les clapets d'aération
hand-operated handle for shutting the flue gas valve and air supply valves
- D rookafrempplaat, verstelbaar
déflecteur, ajustable
flue gas baffle plate, adjustable
- E opschuifbaar vonkenscherm
pare-étincelles escamotable
liftable firescreen
- F optionele convectiekast voor uitstroming warme lucht
chambre de convection en option pour évacuation d'air chaud
optional convection jacket for outlet heated air
- G optionele afwerkingslijst in massief staal (dikte 10 mm)
en option, cadre de finition en acier massif (épaisseur 10mm)
optional finishing frame made of massive steel (10 mm thick)

(STANDARD)



standard built-in ash tray +
cast iron grate

OPTIONAL



optional freestanding Fire Grid
(on the standard built-in ash tray + cast iron grate)



optional freestanding Fire Grid
(on an a plain steel 10 mm bottom plate)

Avenue MF 1050-60 GHE 1S
Concept made to measure
(4-sided finishing frame + horizontal extension + floorplate)



EFFICIENT EN ONBETWIST MOOI

De Avenue vertegenwoordigt de gesloten gashaarden in het Metalfire-gamma. De sleutelwoorden zijn comfort en gebruiksgemak, gepaard met een adembenemend vlammenschouwspel en ongekende sensaties. Personaliseer bovendien uw haard dankzij onze op maat gemaakte concepten rondom uw haard (zie p. 82).

DESIGN REMARQUÉ, EFFICACITÉ REMARQUABLE

L' Avenue est la génération des foyers à gaz fermés dans la gamme Metalfire. Confort et simplicité d'utilisation, avec un étonnant spectacle de la flamme et de nouvelles sensations... ! De plus, imaginez un foyer personnalisé, avec nos concepts sur mesure autour de votre foyer (voir p. 82).

EFFICIENT AND INDISPUTABLY BEAUTIFUL

The Avenue represents closed gas-burning fireplaces in the Metalfire range. Think comfort and ease of use with an astonishing display of flames and an amazing whole new feel! What is more, imagine a personalised hearth surrounded by our customised concepts (see p. 82).



AVENUE *plus* / AVENUE

GESLOTEN GASHAARDEN MET HOOG RENDEMENT

FOYERS FERMÉS AU GAZ À HAUT RENDEMENT

GAS HIGH EFFICIENCY CLOSED FIREPLACES





Avenue MF 1300-60 GHE 3S
Concept made to measure



Avenue MF 1050-75 GHE 1S
Concept made to measure
(4-sided finishing frame + plinth)







Avenue MF 800-75 GHE 1S
(4-sided finishing frame)



Avenue MF 1050-75 GHE 3S
Concept made to measure









Avenue MF 1050 -75 GHE 3S
(3-sided finishing frame + floorplate)

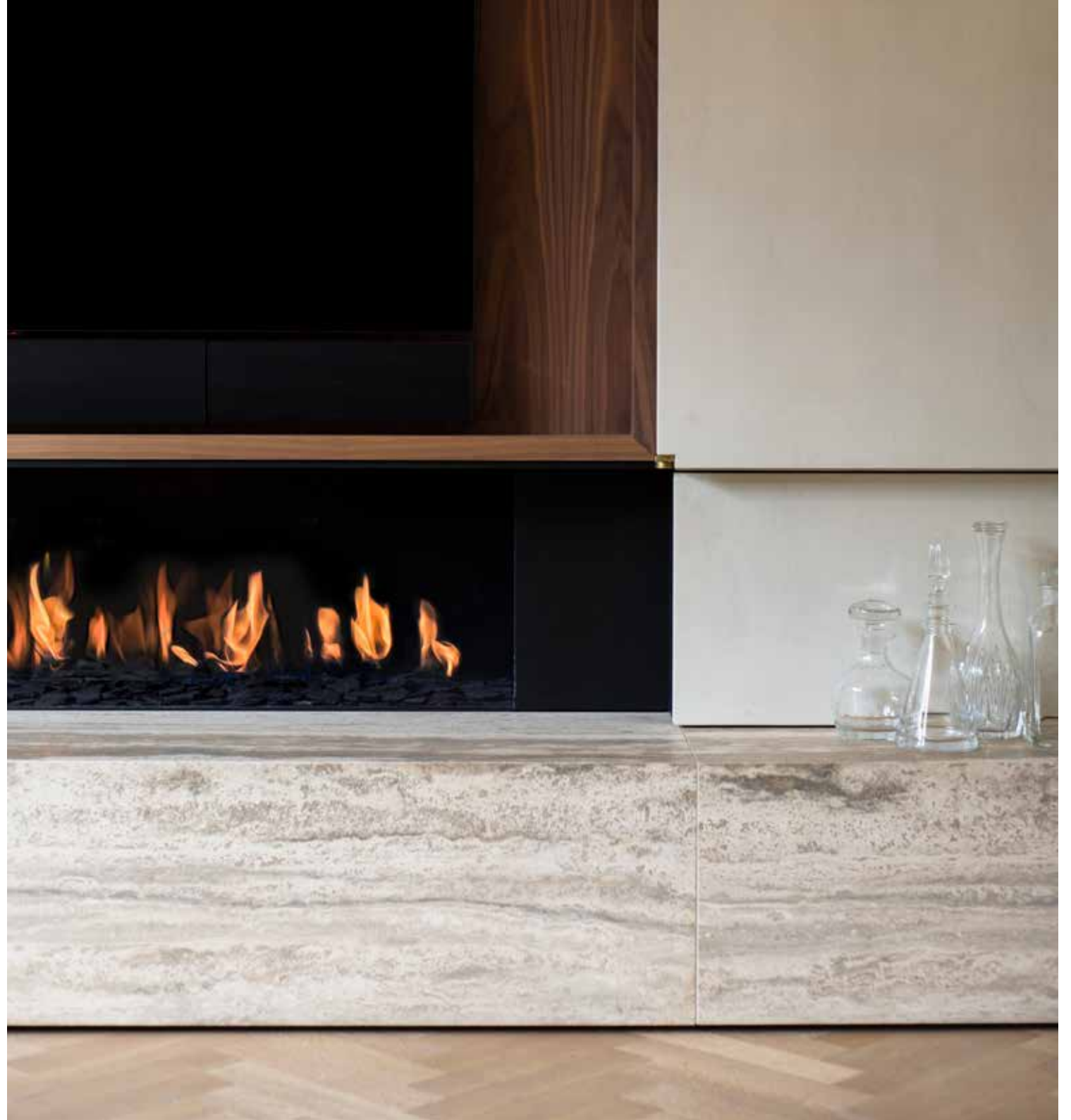

Avenue MF1300-40 GHE 1S
(3-sided finishing frame
+ horizontal extension)





Avenue MF 1300-60 GHE 2S
Concept made to measure
(3-sided finishing frame - convection air slot)



Avenue MF 900-60 GHE 3S EXT



Avenue MF 800-75 GHE 2S
(6-sided finishing frame)











Avenue MF 1300-40 GHE 2S
Concept made to measure
(6-sided finishing fram + horizontal extension)



Avenue MF 1300-40 GHE 2S
(4-sided finishing + horizontal extension)



AVENUE^{plus}

FRONT



AVENUE MF 700-60 GHE 1S	AVENUE MF 800-40 GHE 1S
5,8kW 90%	5,5kW 90%
A	A
B	B

AVENUE MF 800-75 GHE 1S	AVENUE MF 900-60 GHE 1S	AVENUE MF 1050-40 GHE 1S	AVENUE MF 1050-60 GHE 1S	AVENUE MF 1050-75 GHE 1S
8,1kW 84,5%	8,1kW 84,5%	8,0kW 84,8%	9,5kW 87%	9,5kW 87%
B	B	B	A	A
		B	B	B

AVENUE MF 1050-75 GHE 1S	AVENUE MF 1300-40 GHE 1S	AVENUE MF 1300-60 GHE 1S	AVENUE MF 1600-40 GHE 1S
8,3kW 82%	9,5kW 87%	9,6kW 83,3%	9,5kW 87%
B	A	B	A
B	B	B	B

AVENUE MF 1300-60 GHE 1S	AVENUE MF 1600-60 GHE 1S
9,5kW 87%	9,6kW 83,3%
A	B
B	B

AVENUE MF 1300-75 GHE 1S	AVENUE MF 1600-75 GHE 1S
9,5kW 87%	9,6kW 83,3%
A	B
B	B

AVENUE L(large) MF 1300-75 GHE 1S
9,5kW 87%
A

2 SIDES OPEN L/R



AVENUE MF 700-60 GHE 2S L/R	AVENUE MF 800-40 GHE 2S L/R
5,8kW 90%	5,5kW 90%
A	A
B	B

AVENUE MF 800-75 GHE 2S L/R	AVENUE MF 900-60 GHE 2S L/R	AVENUE MF 1050-40 GHE 2S L/R	AVENUE MF 1050-60 GHE 2S L/R	AVENUE MF 1050-75 GHE 2S L/R
8,1kW 84,5%	8,1kW 84,5%	8,0kW 84,8%	9,5kW 87%	9,5kW 87%
B	B	B	A	A
		B	B	B

AVENUE MF 1050-75 GHE 2S L/R	AVENUE MF 1300-40 GHE 2S L/R	AVENUE MF 1300-60 GHE 2S L/R	AVENUE MF 1600-40 GHE 2S L/R
8,3kW 82%	9,5kW 87%	9,6kW 83,3%	9,5kW 87%
B	A	B	A
B	B	B	B

AVENUE MF 1300-60 GHE 2S L/R	AVENUE MF 1600-60 GHE 2S L/R
9,5kW 87%	9,6kW 83,3%
A	B
B	B

AVENUE MF 1300-75 GHE 2S L/R	AVENUE MF 1600-75 GHE 2S L/R
9,5kW 87%	9,6kW 83,3%
A	B
B	B

AVENUE L(large) MF 1300-85 GHE 1S
11,4kW 80%
B

3 SIDES OPEN



AVENUE MF 700-60 GHE 3s	AVENUE MF 800-40 GHE 3s
5,8kW 90%	5,5kW 90%
A	A
B	B

AVENUE MF 800-75 GHE 3s	AVENUE MF 900-60 GHE 3s	AVENUE MF 1050-40 GHE 3s	AVENUE MF 1050-60 GHE 3s	AVENUE MF 1050-75 GHE 3s
8,1kW 84,5%	8,1kW 84,5%	8,0kW 84,8%	9,5kW 87%	9,5kW 87%
B	B	B	A	A
		B	B	B

AVENUE MF 1050-75 GHE 3s	AVENUE MF 1300-40 GHE 3s	AVENUE MF 1300-60 GHE 3s	AVENUE MF 1600-40 GHE 3s
8,3kW 82%	9,5kW 87%	9,6kW 83,3%	9,5kW 87%
B	A	B	A
B	B	B	B

AVENUE MF 1300-60 GHE 3s	AVENUE MF 1600-60 GHE 3s
9,5kW 87%	9,6kW 83,3%
A	B
B	B

AVENUE MF 1300-75 GHE 3s	AVENUE MF 1600-75 GHE 3s
9,5kW 87%	9,6kW 83,3%
A	B
B	B

AVENUE L(large) MF 1300-95 GHE 1S
11,4kW 80%
B

3 SIDES OPEN EXTENDED



AVENUE MF 900-60 GHE 3S EXT	AVENUE MF 1050-40 GHE 3S EXT
9,5kW 84,5%	8,3kW 83%
B	B
B	B

AVENUE MF 900-60 GHE T	AVENUE MF 1050-40 GHE T
9,5kW 84,5%	8,3kW 83%
B	B
B	B

AVENUE MF 900-60 GHE T	AVENUE MF 1050-40 GHE T
9,5kW 84,5%	8,3kW 83%
B	B
B	B

FRONT - BRICK



BRICK AVENUE MF 1050-75 GHE 1S	BRICK AVENUE L MF 1300-75 GHE 1S
9,5kW 87%	11,4kW 80%
A	B

BRICK AVENUE L MF 1300-85 GHE 1S	BRICK AVENUE L MF 1300-95 GHE 1S
11,4kW 80%	11,4kW 80%
B	B

TUNNEL



BRICK AVENUE L MF 1300-95 GHE 1S
11,4kW 80%
B

FINISHING FRAMES | CONCEPTS

CUSTOM MADE

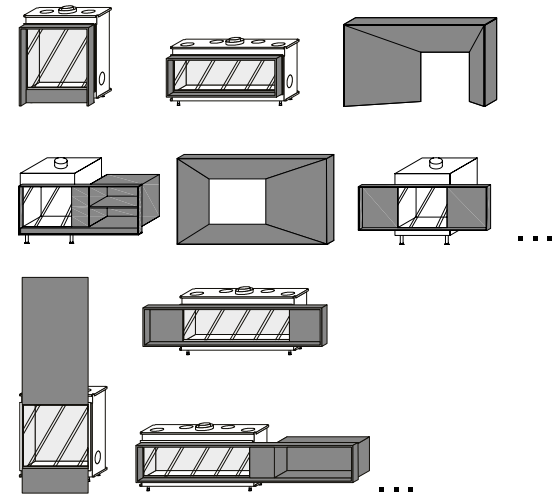

Concepten en kaders zijn ook in **MAATWERK** verkrijgbaar - zie p. 92
 Concepts et cadres également disponibles en **SUR-MESURE** - voir p. 92
 Concepts and frames also available in **MADE-TO-MEASURE** - see p. 92

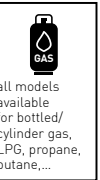

* = OUTPUT (Opgegeven waarden voor gas categorie I₂E+ / Valeurs spécifiées pour catégorie Gaz I₂E+ / Specified values for gas category I₂E+)



AVENUE^{plus}

Ø 80/130 | standaard geleverd met diam. 100/150 mm
 livré standard avec diam. 100/150 mm
 standard delivered with diam. 100/150 mm

AVENUE

Ø 100/150 | standaard geleverd met diam. 130/200 mm
 livré standard avec diam. 130/200 mm
 standard delivered with diam. 130/200 mm

VOORZIENINGEN | APPROVISIONNEMENTS | SUPPLIES

- 1 aanvoer verse lucht middels concentrisch rookkanaal
 apport d'air frais par un conduit de fumée concentrique
 fresh air supply through concentric flue gas duct
- 2 aanvoer kamerlucht/convectielucht
 apport d'air ambiant/air de convection
 ambient air/convection air supply
- 3 afvoer rookgassen
 évacuation des gaz de combustion
 flue gass outlet
- 4 uitstoot verwarmde convectielucht/recuperatiewarmte
 évacuation d'air chaud (air de convection)/ air de récupération
 outlet for heated convection air

KENMERKEN | CARACTÉRISTIQUES | FEATURES

- A afstandsbediening met manuele functie of thermostaat met Eco-Functie
 commande à distance avec fonction manuelle ou thermostat avec Fonction Éco
 remote control with manual function or thermostat with Eco-Function
- B brander met dubbele brander-functie
 brûleur avec fonction de double brûleur
 burner with double burner function
- C stookruimte met STANDARD afwerking (vlakke staalplaat),
 ook ORIGINAL, DESIGN, ROUND & TRIANGLE afwerking verkrijgbaar
 chambre de combustion à finition STANDARD (acier lisse),
 finition ORIGINAL, DESIGN, ROUND & TRIANGLE aussi disponible
 combustion chamber with STANDARD finishing (plain steel),
 ORIGINAL, DESIGN, ROUND & TRIANGLE finishing also available
- D rookafrempelaar in RVS voor hoger rendement
 plaque de décélération des fumées en inox pour un meilleur rendement
 stainless steel flue gas baffle for a higher efficiency
- E glasplaat zonder frame (PREMIUM ontspiegeld glas in optie)
 vitre sans cadre (verre antireflet PREMIUM en option)
 glass without frame (optional PREMIUM non reflective glass)
- F standaard uitgevoerd met convectiekast voor betere doorstroming kamerlucht
 finition standard avec chambre de convection pour une meilleure circulation de l'air ambiant
 convection chamber is a standard feature enhancing the circulation of ambient air
- G optioneel afwerkingskader in massief staal (dikte 10 mm)
 en option, cadre de finition en acier massif (épaisseur 10mm)
 optional finishing frame made of solid steel (10 mm thick)
- H regelvoetjes te bedienen via de binnenzijde van de haard voor handig en perfect afstellen
 pieds réglables depuis l'intérieur du foyer pour une disposition pratique et précise
 leg levellers to be operated on the inside of the fireplace for easy and perfect adjustment



ECOWAVE-FUNCTIE TOT 40% BESPARING OP GASVERBRUIK

In ECOWAVE-stand gaat de vlamhoogte automatisch en afwisselend van hoogste naar laagste stand. Dit geeft enerzijds een dynamisch vuur (en zéér realistisch imitatie houtvuur in combinatie met de keramische houtblokken!), en anderzijds een besparing op het gasverbruik van 40% tegenover de vaste hoogste stand. Dynamiek, esthetiek, én besparing in één functie!

FONCTION ECOWAVE JUSQU'À 40 % D'ÉCONOMIE SUR VOTRE CONSOMMATION DE GAZ

En mode ECOWAVE, la hauteur de flamme varie automatiquement de la position la plus haute à la position la plus basse. Cela crée, d'une part, un feu dynamique (et une imitation très réaliste du feu à bois combiné avec des bûches céramiques !) et, d'autre part, une économie sur la consommation de gaz de l'ordre de 40 %, par rapport à une flamme constamment en position la plus haute. Dynamisme, esthétique et économie concentrés en une fonction !

ECOWAVE FEATURE SAVE UP TO 40% ON GAS CONSUMPTION

In ECOWAVE mode, the flame height alternates automatically between the highest and lowest position. Not only does this result in a dynamic fire (a very realistic imitation wood fire combined with the ceramic logs!), but it also uses 40% less gas than the fixed highest position. Dynamic, aesthetically pleasing and cost-saving — all in one feature!



DUBBELE BRANDER EEN AANGENAAM VUUR OP 50% VERMOGEN

Voor de AVENUE-collectie werd een volledig nieuw brandersysteem ontwikkeld. Naast de ECOWAVE-functie, werd immers het brandersysteem opgebouwd uit 2 branders. Voor sfeer en gezelligheid geeft de binnenliggende brander (dus 1 brander) een beperkt maar realistisch imitatie houtvuur, en ongeveer 50% van het vermogen van het brandersysteem. Ideaal als u een mooi vuur wenst, maar minder verwarming. Bij gebruik van de binnenliggende én buitenliggende brander tesamen, wordt het maximaal vermogen van de haard gebruikt, wat resulteert in maximale verwarming!

DOUBLE BRÛLEUR UN FEU AGRÉABLE À 50 % DE CAPACITÉ

Pour la collection AVENUE, un tout nouveau système de brûleur a été développé. En plus de la fonction ECOWAVE, le système s'appuie sur 2 brûleurs. Afin de créer une ambiance agréable, le brûleur intérieur (soit 1 brûleur) produit un feu limité mais imitant de façon réaliste un feu de bois, tout en n'utilisant environ que 50 % de la capacité du système de brûleur. Idéal lorsque vous désirez un beau feu, mais moins de chauffage. En cas d'utilisation simultanée du brûleur intérieur et extérieur, la capacité maximale du foyer est exploitée, ce qui donne un maximum de chauffage.

DOUBLE BURNER AN AGREEABLE FIRE WITH 50% OF THE POWER

An entirely new burner system was designed for the AVENUE collection. In addition to the ECOWAVE feature, there is the burner system, consisting of 2 burners. To create a cosy atmosphere, light the interior burner (so only 1 burner) for a subtle, but realistic imitation wood fire, using only 50% of the burner system's power. Perfect if you want a lovely fire, but less heating. If you light both the interior and exterior burners simultaneously, you will use the fireplace's maximum power, thus creating maximum heating!

AVENUE^{plus}

- aansluiting rookkanaal diam. 100/150 mm
- eveneens mogelijk aan te sluiten op diam. 80/125 mm, afhankelijk van het verloop van het rookkanaal (zie handleiding) mits verloopstuk US 10A0052
- eveneens geschikt voor aansluiting met mechanische rookgasafvoer
- raccordement diam. 100/150 mm
- aussi possible de raccorder au conduit diam. 80/125 mm selon le trajet du conduit (à voir le guide d'installation), et en conséquence d'une pièce US 10A0052
- aussi approprié pour raccord avec extracteur de gaz de fumée
- flue pipe connector diam. 100/150 mm
- also possible to connect to a diam. 80/125 mm, depending on the flue route (see installation manual), and with reducer US 10A0052
- also suitable for connection to a mechanical smoke fan

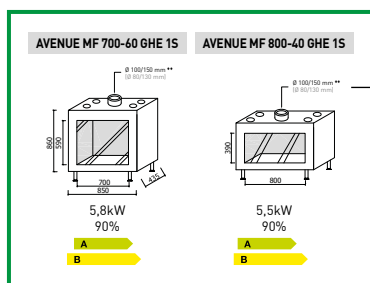

- + dubbele brander met ECOWAVE afstandsbediening met thermostaat en weekprogramma
- + brûleur double avec ECOWAVE télécommande thermostatique avec programme hebdomadaire
- + double burner with ECOWAVE function
- + remote control with programmable thermostat

AVENUE

- aansluiting rookkanaal diam. 130/200 mm
- eveneens mogelijk aan te sluiten op diam. 100/150 mm, afhankelijk van het verloop van het rookkanaal (zie handleiding) mits verloopstuk US 13A0006
- eveneens geschikt voor aansluiting met mechanische rookgasafvoer
- raccordement diam. 130/200 mm
- aussi possible de raccorder au conduit diam. 100/150 mm selon le trajet du conduit (à voir le guide d'installation), et en conséquence d'une pièce US 13A0006
- aussi approprié pour raccord avec extracteur de gaz de fumée
- flue pipe connector diam. 130/200 mm
- also possible to connect to a diam. 100/150 mm, depending on the flue route (see installation manual), and with reducer US 13A0006
- also suitable for connection to a mechanical smoke fan

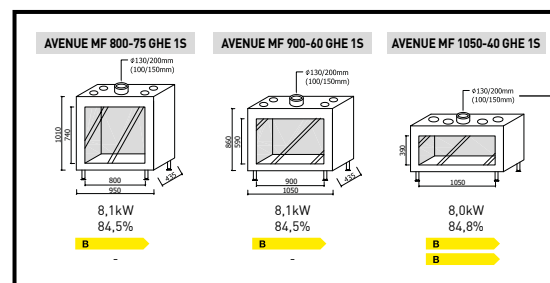

- + dubbele brander met ECOWAVE afstandsbediening met thermostaat en weekprogramma
- + brûleur double avec ECOWAVE télécommande thermostatique avec programme hebdomadaire
- + double burner with ECOWAVE function
- + remote control with programmable thermostat

BEKLEDING BRANDER | FINITION DU BRÛLEUR | BURNER FINISH

KERAMISCHE BLOKKEN
BÛCHES CÉRAMIQUES
WOOD LOGS



TOESTELLEN MET HOOGTE STOOKOPENING 40 EN 60 CM:

Standaard uitgerust met keramische houtblokken Smoke Style.

NIET beschikbaar met keien of woodchips.

APPAREILS AVEC UNE HAUTEUR DE VISION DE FEU

DE 40 ET 60 CM : Équipé de série de bûches céramiques Smoke Style.

PAS disponible avec galets et chips en bois.

APPLIANCES WITH A 40 AND 60 CM HIGH FIREPLACE OPENING:

Standard version comes equipped with ceramic logs Smoke Style.

NOT available with pebbles or woodchips.

See p.107

BEKLEDING BRANDER | FINITION DU BRÛLEUR | BURNER FINISH

WITTE KEIEN
CAILLOUX BLANCS
WHITE PEBBLES

See p.111



TOESTELLEN MET HOOGTE STOOKOPENING 40 CM: Standaard uitgerust met witte keien, en zonder meerprijs op aanvraag met grijze keien of woodchips. Optioneel en met meerprijs beschikbaar met keramische houtblokken Classic Style.

APPAREILS AVEC UNE HAUTEUR DE VISION DE FEU DE 40 CM : Équipé de série de galets blancs, et sur demande de galets gris ou de chips en bois, sans majoration de prix. Disponible en option équipé de bûches céramiques Classic Style, avec majoration de prix.

APPLIANCES WITH A 40 CM HIGH FIREPLACE OPENING: Standard version comes with white pebbles, which can be substituted for grey pebbles or woodchips upon request, at no additional charge. Ceramic logs Classic Style available as an option, at an additional charge.

GRIJZE KEIEN
CAILLOUX GRIS
GREY PEBBLES

See p.111



HOUTCHIPS
CHIPS EN BOIS
WOODCHIPS

See p.110



TOESTELLEN MET HOOGTE STOOKOPENING 60 EN 75 CM: Standaard uitgerust met keramische houtblokken Smoke Style.

NIET beschikbaar met keien of woodchips.

APPAREILS AVEC UNE HAUTEUR DE VISION DE FEU

DE 60 ET 75 CM : Équipé de série de bûches céramiques Smoke Style.

PAS disponible avec galets et chips en bois.

APPLIANCES WITH A 60 AND 75 CM HIGH FIREPLACE OPENING: Standard version comes equipped with ceramic logs Smoke Style.

NOT available with pebbles or woodchips.

KERAMISCHE BLOKKEN
BÛCHES CÉRAMIQUES
WOOD LOGS - SMOKE STYLE

See p.107



KERAMISCHE BLOKKEN
BÛCHES CÉRAMIQUES
WOOD LOGS - CLASSIC STYLE

See p.109



DEURSYSTEMEN • EENVOUDIG EN SUBTIEL

Voor een optimaal zicht op het vuur en een meest strakke uitvoering zonder enig zichtbaar kader of screening, werd de volledige collectie AVENUE voorzien van een glasplaat welke d.m.v. meegeleverde zuignappen kan worden weggenomen. Hiervoor is geen bijkomend gereedschap vereist. Eén eenvoudige handeling maakt het glas los, waarna het zonder enige moeite kan worden weggenomen. **Gebruiksgemak dus, maar ook plaatsingssnelheid, én onderhoudsefficiëntie!**

SYSTÈMES DE PORTES • SIMPLES ET SUBTILS

Pour une vue idéale sur le feu et une exécution la plus sobre possible sans cadre ou écran apparents, l'ensemble de la collection AVENUE a été pourvu d'une plaque de verre laquelle peut être démontée à l'aide des ventouses livrées avec le foyer. Cela ne nécessite aucun outil complémentaire. Une simple manœuvre permet de détacher le vitrage, et ensuite de l'enlever sans difficulté. **Résultat : fonctionnalité, mais aussi facilité d'installation, et efficacité d'entretien !**

DOOR SYSTEMS • SIMPLE AND SUBTLE

For an optimal view of the fire and an ultra-clean design without any visible frame or screening, the entire AVENUE collection has been fitted with a glass plate that can be dismantled with the included suction cups. No additional tools are needed. The glass can be detached in one simple movement and then easily dismantled. **User-friendly, easy to install and to maintain!**

DEURSYSTEEM | SYSTÈME DE PORTE | DOOR SYSTEM



GLASPLAAT ZONDER KADER OF SCREENING!

- makkelijk weg te nemen glasplaat d.m.v. meegeleverde zuignappen, zonder bijkomend gereedschap, schroeven,...
- verkrijgbaar met optioneel PREMIUM ontspiegeld glas

PLAQUE DE VERRE SANS CADRE OU SCREENING !

- plaque de verre facilement amovible à l'aide de ventouses livrées avec le foyer et sans utilisation d'outils, écrous...
- disponible en option avec vitrage antireflets PREMIUM

GLASS PLATE WITHOUT FRAME OR SCREENING!

- easily dismantlable glass plate thanks to the included suction cups, requiring no additional tools or screws
- available with optional PREMIUM anti-reflective glass

BINNENAFWERKING FINITION INTÉRIEURE INTERIOR FINISH

STANDARD

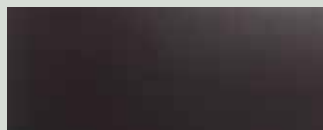

Vlakke staalplaat (4mm)
Acier lisse (4mm)
Flat steel plate (4mm)

ORIGINAL

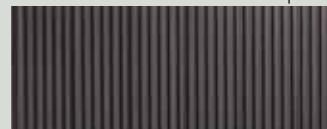

Verticaal geribde gietijzeren lamellen (20mm)
Lamelles verticales striées en fonte (20mm)
Vertical ribbed cast iron (20mm)

DESIGN

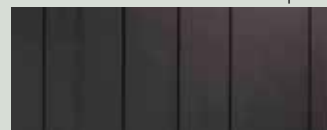

Asymmetrische stalen lamellen (10mm)
Lamelles asymétriques en acier (10mm)
Asymmetrical steel streaks (10mm)

TRIANGLE

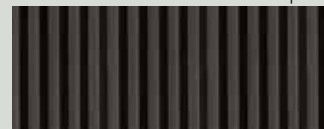

Verticaal gekartelde gietijzeren lamellen (20mm)
Lames en fonte dentelées verticalement (20 mm)
Vertically serrated cast iron (20mm)

ROUND

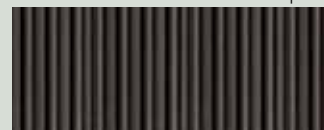

Verticaal afgeronde gietijzeren lamellen (20mm)
Lames en fonte arrondies verticalement (20mm)
Vertically rounded cast iron (20mm)

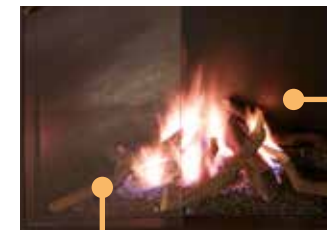

Keramisch glas (standaard)
Verre céramique (standard)
Ceramic glass (standard)

Optioneel PREMIUM ontspiegeld
keramisch glas (10-lagig)
Verre céramique antireflet PREMIUM
en option (10 couches)
Optional PREMIUM non reflective
ceramic glass (10 layers)





Urban MF 1300-40 G 3S (made to measure)

DESIGN EN TECHNOLOGIE

De gasgestookte open haarden van Metalfire brengen een minimalistisch design uitgerust met een intelligente beveiliging. Ze koppelen een strak binnenwerk en zuivere lijnen, zonder zichtbaar kader, aan het comfort van de hedendaagse technologie: een gasunit met een keienbed van lavastenen, woodchips of natuurgetrouwe keramische houtblokken. Voor woningen gebouwd volgens de nieuwste bouwvoorschriften, zijn een bijkomende rookterugslagbeveiliging, rookgasventilator en elektrisch gestuurde afsluitbare kleppen beschikbaar, die deze combinatie perfect mogelijk en veilig maken.

DESIGN ET TECHNOLOGIE

Les foyers ouverts au gaz de Metalfire proposent un design minimaliste rehaussé d'une sécurisation intelligente. Ils allient une finition intérieure radicale et pureté des lignes, sans cadre visible, au confort des technologies les plus récentes: un foyer au gaz sur lit de galets en pierre de lave, de chips en bois ou en bûches de céramique à l'aspect naturel. Pour des bâtiments neufs, construits selon les plus nouvelles normes, il y a plusieurs options disponibles, comme des ventilateurs de gaz de fumées, des clapets d'aération et clapets de gaz de fumées à fermeture électrique, une protection anti-retour thermique,...

DESIGN AND TECHNOLOGY

Metalfire's gas-burning open fireplaces bring a minimalist design fitted with an intelligent protection. They couple taut interior parts and pure lines, without visible frame, to the comfort of the latest technology: a gas unit with a stone bed comprising lava stones, woodchips or true-to-nature wood logs. For new houses, built according to the latest building regulations, different options are available, e.g. mechanical flue gas fans, electric flue gas valves and air supply valves, a thermal rebound protection,...



CUSTOM MADE

URBAN

GASGESTOOKTE OPEN HAARDEN
FOYERS OUVERTS AU GAZ
GAS-BURNING OPEN FIREPLACES





Urban MF W 3S EXT room divider (made to measure)
Concept made to measure
(5-sided finishing frame)



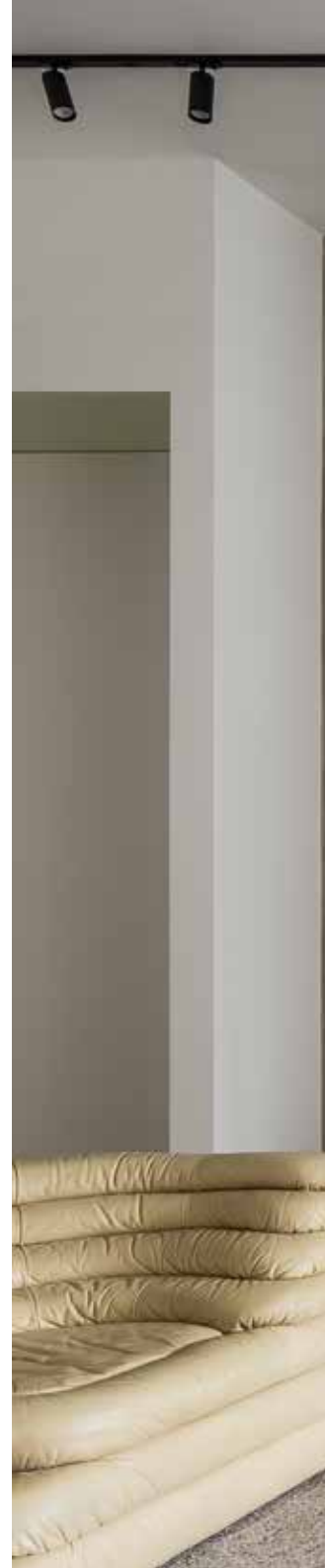





Urban MF 1300-95 G 1S (made to measure)







Urban MF 1300-50 G 3S (made to measure)

Urban MF G 4S (made to measure)
Concept made to measure
(floorplate + horizontal extension)









Urban MF G 4S (made to measure)

Urban MF 2400-50 G 2S







Urban made to measure





Urban MF 1300-75 G 3S
(4-sided finishing frame + horizontal extension)







AFMETINGEN | DIMENSIONS | DIMENSIONS

CUSTOM MADE

FRONT

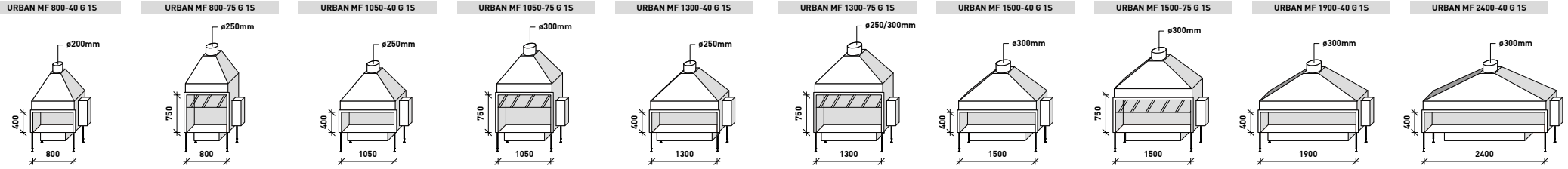

2 SIDES OPEN L/R

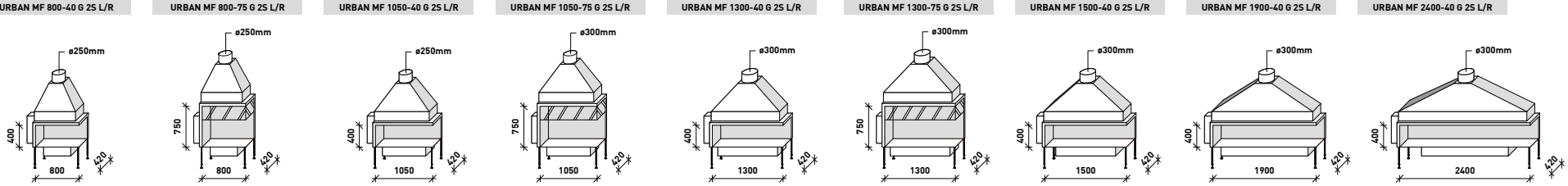

TUNNEL

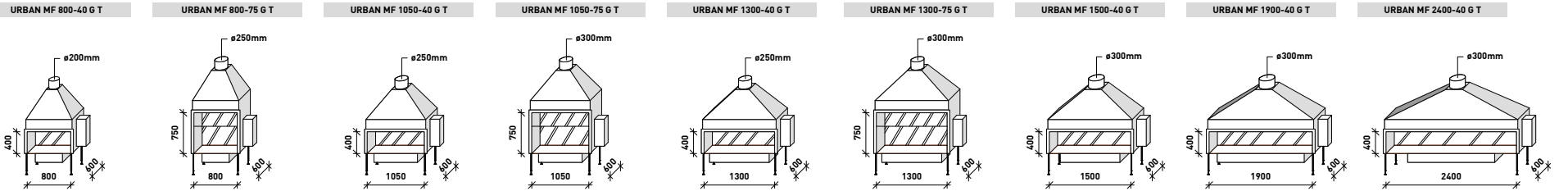

3 SIDES OPEN

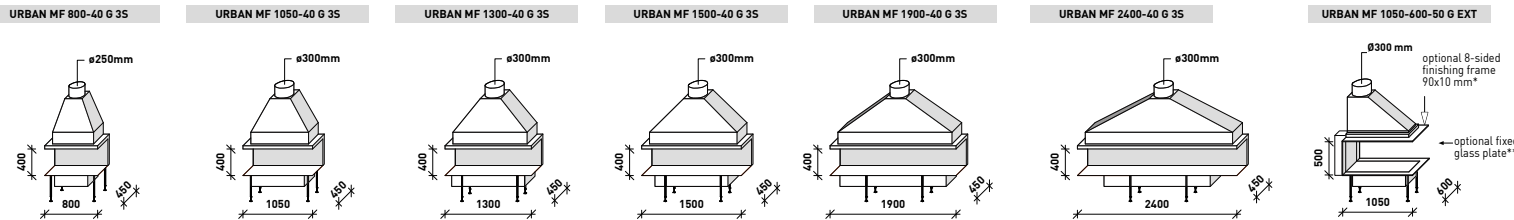

 all models available for bottled/cylinder gas, LPG, propane, butane,...

OPTIES | OPTIONS | OPTIONS

FINISHING FRAMES

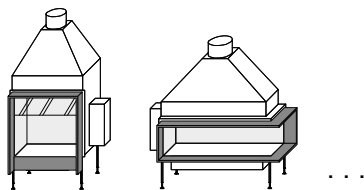

CONCEPTS

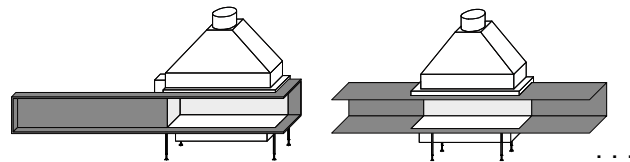

CONVECTION JACKET

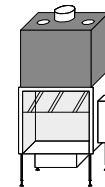

Alle tekeningen van de Metalfire haarden zijn te downloaden als PDF, DWG, STEP (3D) op www.metalfire.eu

Tous les dessins des foyers Metalfire peuvent être téléchargés en PDF, en DWG, STEP (3D) sur www.metalfire.eu

All drawings of the Metalfire fireplaces can be downloaded as a PDF, DWG, STEP (3D) file on www.metalfire.eu.

Concepten en kaders zijn ook in **MAATWERK** verkrijgbaar: zie p. 92 | Concepts et cadres également disponibles en **SUR-MESURE**: voyez p. 92 | Concepts and frames also available in **MADE-TO-MEASURE**: see p. 92

CUSTOM MADE

BINNENAFWERKING | FINITION INTÉRIEURE | INTERIOR FINISH

STANDARD



Vlakke staalplaat (4mm)
Acier lisse (4mm)
Flat steel plate (4mm)

DESIGN



Asymmetrische stalen lamellen (10mm)
Lamelles asymétriques en acier (10mm)
Asymmetrical steel streaks (10mm)
See p.113

TRIANGLE



Verticaal gekartelde gietijzeren lamellen (20mm)
Lames en fonte dentelées verticalement (20 mm)
Vertically serrated cast iron (20mm)
See p.115

ORIGINAL



Verticaal geribde gietijzeren lamellen (20mm)
Lamelles verticales striées en fonte (20mm)
Vertical ribbed cast iron (20mm)
See p.112

ROUND



Verticaal afgeronde gietijzeren lamellen (20mm)
Lames en fonte arrondies verticalement (20mm)
Vertically rounded cast iron (20mm)
See p.114

BEKLEDING BRANDER | FINITION DU BRÛLEUR | BURNER FINISH

WITTE KEIEN
CAILLOUX BLANCS
WHITE PEBBLES
See p.111



GRIJZE KEIEN
CAILLOUX GRIS
GREY PEBBLES
See p.111



HOUTCHIPS
CHIPS EN BOIS
WOODCHIPS
See p.110



KERAMISCHE BLOKKEN
BÛCHES CÉRAMIQUES
WOOD LOGS - CLASSIC STYLE
See p.108



KERAMISCHE BLOKKEN
BÛCHES CÉRAMIQUES
WOOD LOGS - SMOKE STYLE
See p.106

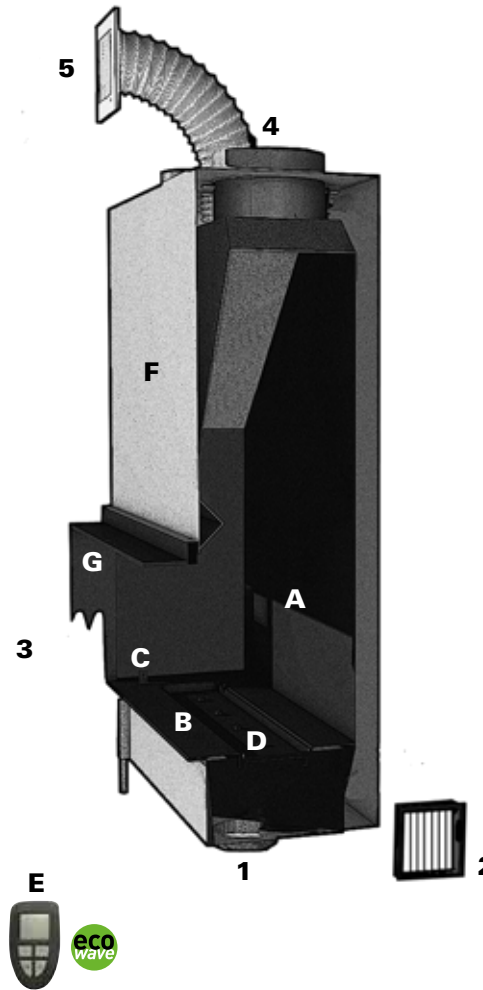

VOORZIENINGEN | APPROVISIONNEMENTS | SUPPLIES

- 1 aanvoer verse lucht
apport d'air frais
fresh air supply
- 2 aanvoer kamerlucht/convectielucht
apport d'air ambiant/air de convection
ambient air/convection air supply
- 3 primaire luchttoevoer/verbrandingslucht
apport d'air primaire/air de combustion
primary air supply/combustion air
- 4 afvoer rookgassen
évacuation des gaz de combustion
flue gas outlet
- 5 uitstoot verwarmde convectielucht/recuperatiewarmte
évacuation d'air chaud (air de convection)/ air de récupération
outlet for heated convection air

KENMERKEN | CARACTÉRISTIQUES | FEATURES

- A stookruimte met STANDARD afwerking (vlakke staalplaat), ook ORIGINAL, DESIGN, ROUND & TRIANGLE afwerking verkrijgbaar
chambre de combustion à finition STANDARD (acier lisse), finition ORIGINAL, DESIGN, ROUND & TRIANGLE aussi disponible
combustion chamber with STANDARD (flat steel plate), ORIGINAL, DESIGN, ROUND & TRIANGLE finishing also available
- B stookbodem in vlak staal 10 mm
sole foyère en acier de 10 mm
10 mm flat steel firing bottom plate
- C manueel te bedienen hendel voor afsluiten rookgasklep en beluchtungskleppen
poignées à ouverture manuelle pour le réglage du clapet des gaz de combustion et les clapets d'aération
hand-operated handle for shutting the flue gas valve and air supply valves
- D brander met beveiligde waakvlamset en oxy-pilot
brûleur avec veilleuse flamme protégée et oxypilote
burner with protected pilot flame set and oxy-pilot
- E afstandsbediening met ECOWAVE-functie voor verlaging verbruik -30%
commande à distance avec fonction ECOWAVE pour réduire la consommation -30%
remote control with ECOWAVE-function for reducing consumption -30%
- F optionele convectiekast voor uitstroming warme lucht
chambre de convection en option pour évacuation d'air chaud
optional convection jacket for outlet heated air
- G optionele afwerkingslijst in massief staal (dikte 10 mm)
en option, cadres de finitions en acier massif (épaisseur 10mm)
optional finishing frame made of solid steel (10 mm thick)



CUSTOM MADE

EEN UNIEKE AANTREKKINGSKRACHT

Naast de haardencollectie is Metalfire eveneens gespecialiseerd in aanvullend MAATWERK, afwerkingskaders, concepten, vloerplaten, houtbergingen, ... Deze stukken worden geproduceerd op basis van het ontwerp van de klant/architect/interieurarchitect.

De technische afdeling legt vooraf het productieplan ter goedkeuring voor aan de klant, en vervolgens worden deze unieke stukken in de praktijk omgezet door de vaardige handen van de vakmensen in het atelier. Het geeft de producten een unieke aantrekkingskracht, die door geautomatiseerde productieprocessen gewoonweg niet kan worden gerealiseerd.

UN CHARME UNIQUE

En plus de sa collection de foyers, Metalfire propose également du sur-mesure spécialisé, des cadres de finition, des concepts, des plaques de sol et des solutions de rangement de bûches. Ces pièces sont produites sur la base du concept présenté par le client, l'architecte ou l'architecte d'intérieur.

La division technique soumet toujours le plan de production au client avant que ces pièces uniques ne soient adaptées dans la pratique grâce au savoir-faire artisanal de nos spécialistes à l'atelier. Ces interventions procurent aux produits un attrait unique, qui ne peut pas être obtenu au moyen de processus de production automatisés.

A UNIQUE APPEAL

Our Metalfire collection is complemented by the additional made to measure solutions, finishing frames, concepts, floor plates, wood storage, ... These items are produced based on the design provided by the customer/architect/interior designer.

The technical department always presents the production plan to the customer for approval, after which these unique pieces are manufactured by the skilled craftsmen in our workshop. This gives a unique appeal to the products, which simply cannot be obtained through automated production processes.

MAATWERK SUR-MESURE MADE-TO-MEASURE

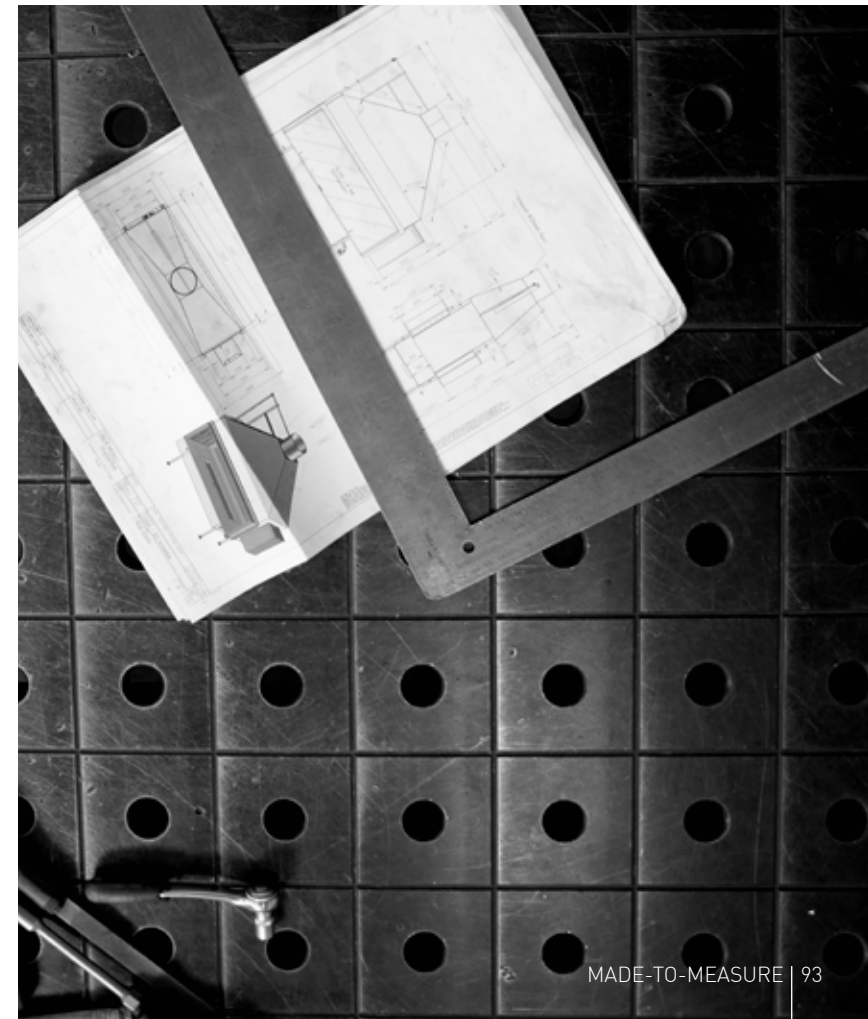



ANEMONE extra large
(FIRE BASKET)

METALFORMS

by *Metalfire*

Naast de haardcollecties brengt Metalfire een volledige accessoirelijn onder de naam METALFORMS.
Info: zie www.metalfire.eu.

Outre sa collection de foyers ouverts architecturaux, Metalfire propose également une gamme complète d'accessoires sous le nom de METALFORMS
Info: voir www.metalfire.eu.

Apart from our collection of architectural fireplaces, Metalfire also boasts a complete line of accessories under the name of METALFORMS.
Info: see www.metalfire.eu.

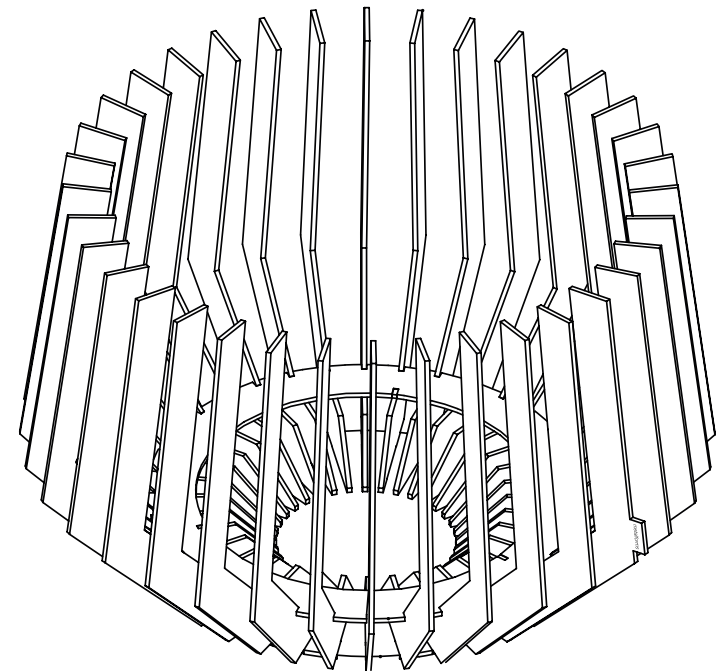

ANEMONE

WOOD SMALL (AN.S)

Ø 57 cm x H 50 cm, 50 kg

WOOD MEDIUM (AN.M)

Ø 68 cm x H 57 cm, 70 kg

WOOD EXTRA-LARGE (AN.XL)

Ø 145 cm x H 89 cm, 350 kg

BIO-ETHANOL (AN.BIO)

Ø 55 cm x H 51 cm, 50 kg

* bio-ethanol burner 2,5L, AB3 + glass safety protection, lighter, ... included



BIO-ETHANOL



WOOD SMALL



WOOD MEDIUM











WOOD EXTRA LARGE





METALFORMS®

FIRE GRID

FG. 01			width 50 cm depth 35 cm
FG. 02			width 50 cm depth 37,5 cm
FG. 03			width 50 cm depth 37,5 cm
FG. 04			width 50 cm depth 35 cm
			width 80 cm depth 46 cm

FIRE GRID GAS



FIRE GRID GAS 80 cm + Logburner length 50cm + ceramic logs Smoke style/Classic style, technical box is built-in

FIRE GRID GAS 110 cm + Logburner length 80cm + ceramic logs Smoke style/Classic style, technical box is built-in

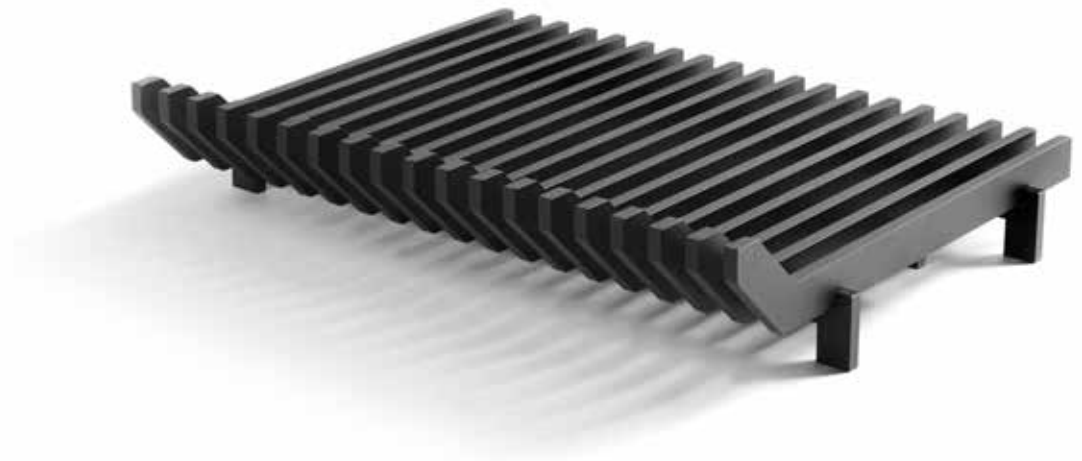



Fire grid gas





Company

Ons bedrijf is sterk geworteld in de Belgische grond en hecht veel belang aan waarden als integriteit, verantwoordelijkheid en vertrouwen. Het staat dan ook voor no-nonsense ondernemerschap. Metalfire beschikt over een eigen machinepark waardoor onze haarden voor 100% gemaakt kunnen worden in eigen atelier te Evergem-België. Met een eeuwig brandende passie voor schoonheid bouwen wij innovatieve haarden, gekenmerkt door een air van grandeur. Het is dankzij deze toewijding dat Metalfire-haarden nu verdeeld en gesmaakt worden over de hele wereld. Met het Metalfire-ontwikkelingsprogramma houden we onze wereldwijde verdelers op de hoogte en bieden we hen de mogelijkheid de beste service te verlenen.

Fermeement attachée à la fois au sol belge et à des valeurs comme l'intégrité, la responsabilité et la confiance, notre entreprise est adepte de l'entrepreneuriat réaliste. Metalfire dispose de son propre parc de machines afin que nos foyers puissent être fabriqués à 100 % dans notre propre atelier à Evergem. Notre éternelle passion pour la beauté nous pousse à créer des foyers innovants dotés d'une touche indéniable de grandeur. C'est aussi cette passion qui fait que les foyers Metalfire sont à présent distribués et appréciés partout dans le monde. Grâce au programme de développement Metalfire, nous informons nos distributeurs internationaux et leur permettons de garantir le meilleur service possible.

Our company is firmly rooted in the Belgian soil, and treasures values such as integrity, accountability and trust. It also stands for no-nonsense entrepreneurship. Metalfire has its own machinery with which our fireplaces can be 100% manufactured in our own workshop in Evergem. With an ever-burning passion for beauty that leads us to build innovative fireplaces that have an unmistakable air of grandeur. It's thanks to this dedication that Metalfire fireplaces are now distributed and enjoyed all over the world. The Metalfire development program keeps our global distributors informed, and we enable them to offer the best service possible.

Een 100% Belgisch bedrijf
Une entreprise 100 % Belge
A 100% Belgian company

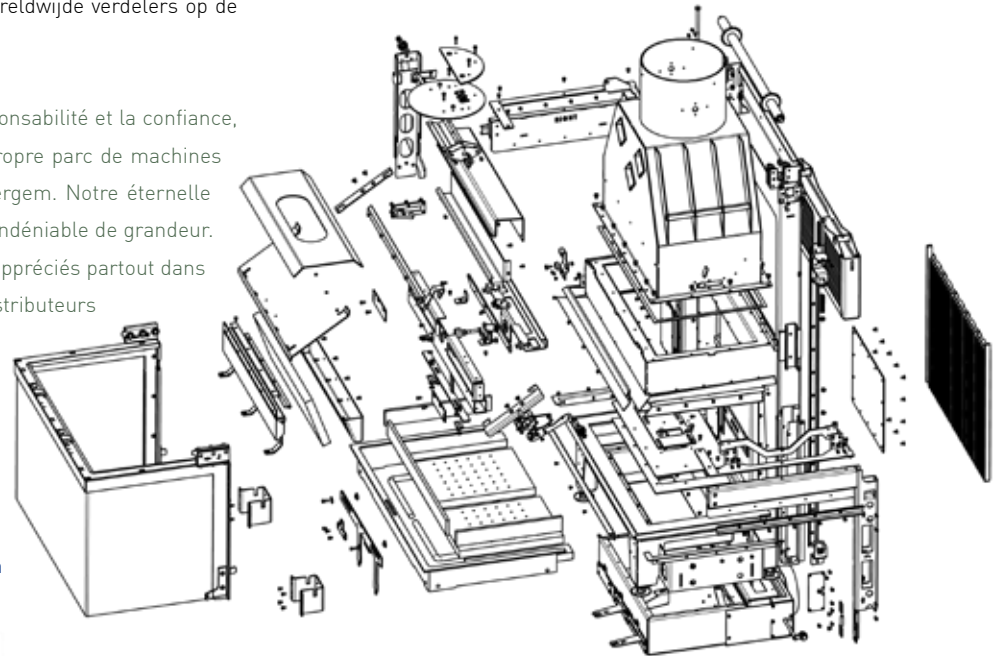



1545/150 P-CH
EN 388 : 2015
21-218
Trousse : 8
EN 12477-2
K1520X
EN 12477-2

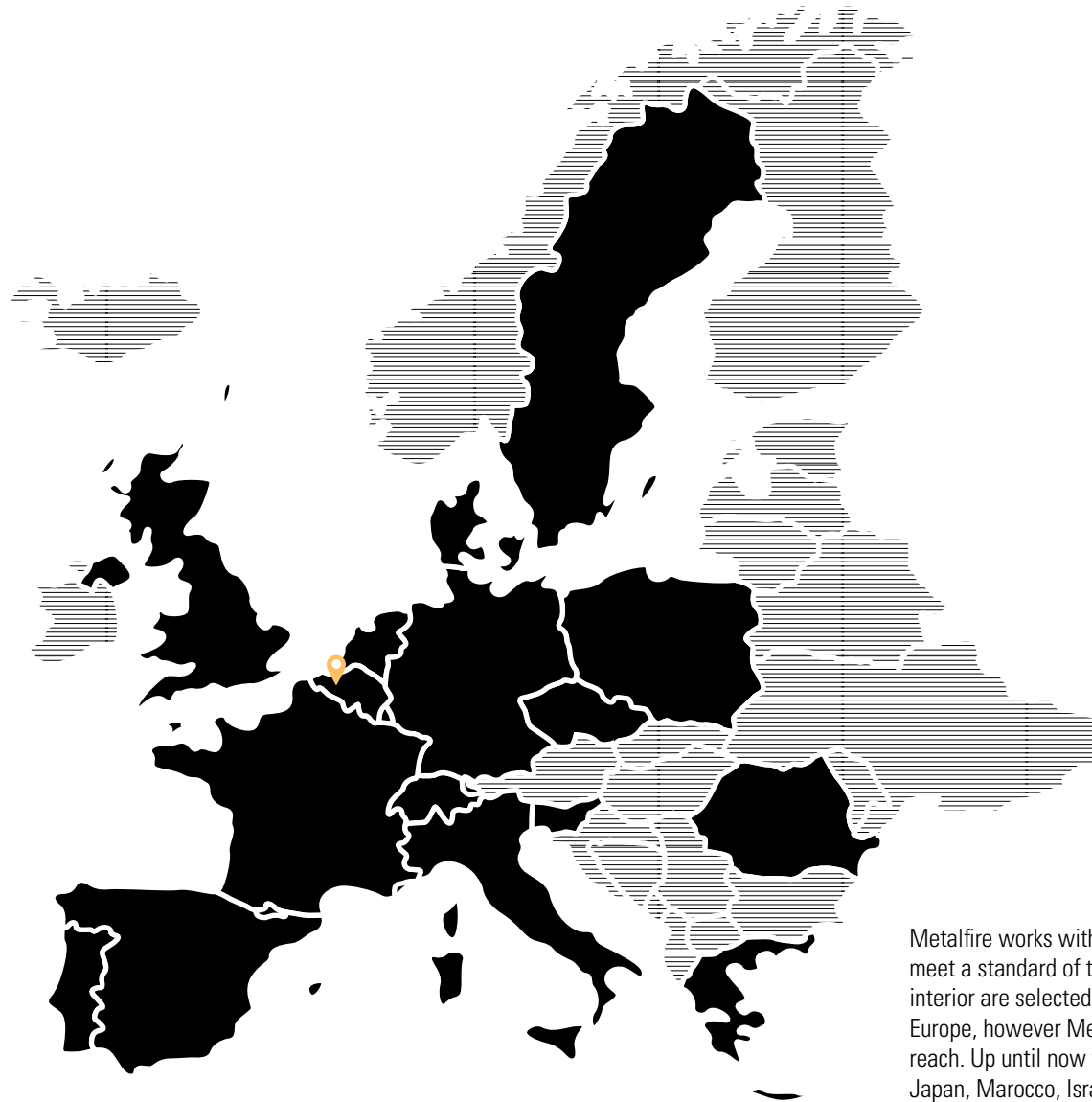

Metalfire works with a dedicated group of resellers. Only the resellers who meet a standard of technical knowledge and skill in building a fireplaces interior are selected to sell Metalfire. Most of our resellers are located in Europe, however Metalfire is globally known thus we are expanding our reach. Up until now we have resellers in 4 countries outside of europe: Japan, Marocco, Israel and Russia.
Metalfire HQ & Production 📍



Metalfire begrijpt dat onze planeet een van onze meest waardevolle maar tegelijk ook een van onze meest delicate bronnen is. We streven ernaar onze ecologische voetafdruk over de volledige waardeketen te minimaliseren, met kleinere bijdragen zoals zonnepanelen en intelligente verlichting, maar ook met echte baanbrekende innovaties in onze productieprocessen en producten.

Bovendien zien we toe op een duurzame inkoop van onze grondstoffen en hun respectieve bevoorradingsketens. We focussen ons op een stabiele bevoorrading van hoogkwalitatieve grondstoffen op lange termijn, en trachten zo transparant en overzichtelijk mogelijk te zijn wat de impact op het milieu en de maatschappij betreft.

Metalfire a conscience que notre planète est notre ressource la plus précieuse, mais aussi la plus fragile. Nous nous efforçons de réduire notre empreinte écologique au minimum sur l'ensemble de la chaîne de valeur, à la fois par des interventions de petite ampleur comme l'utilisation de panneaux solaires et d'éclairage intelligent, mais aussi au moyen de véritables innovations pionnières dans nos processus de production et nos produits.

En outre, nous veillons à l'approvisionnement durable de nos matières premières et à leurs chaînes logistiques respectives. Nous mettons l'accent sur un approvisionnement stable et à long terme de matières premières de qualité supérieure ainsi que sur le meilleur degré possible de transparence et de surveillance des incidences environnementales et sociales.

Metalfire appreciates that our planet is one of our most valuable, but also one of our most vulnerable, resources. We aim to minimise our environmental footprint along the entire value chain, both with smaller measures such as solar panels and smart lighting, and with genuinely ground-breaking innovations in our production processes and products.

Additionally, we ensure the sustainable sourcing of our raw materials and their respective supply chains. Our focus is on a stable supply of high-quality raw materials in the long-term, and we try as much as possible to ensure the greatest possible transparency and oversight of environmental and social impacts.

Materials

Details van de binnenafwerking

Détails de la finition intérieure

[Details of the interior finish](#)



URBAN

BEKLEDING BRANDER | FINITION DU BRÔLEUR | BURNER FINISH

KERAMISCHE BLOKKEN / BÛCHES CÉRAMIQUES / WOOD LOGS - SMOKE STYLE



AVENUE

BEKLEDING BRANDER | FINITION DU BRÔLEUR | BURNER FINISH

KERAMISCHE BLOKKEN / BÛCHES CÉRAMIQUES / WOOD LOGS - SMOKE STYLE



URBAN

BEKLEDING BRANDER | FINITION DU BRÛLEUR | BURNER FINISH

KERAMISCHE BLOKKEN / BÛCHES CÉRAMIQUES / WOOD LOGS - CLASSIC STYLE



AVENUE

BEKLEDING BRANDER | FINITION DU BRÔLEUR | BURNER FINISH

KERAMISCHE BLOKKEN / BÛCHES CÉRAMIQUES / WOOD LOGS - CLASSIC STYLE



AVENUE / URBAN

BEKLEDING BRANDER | FINITION DU BRÔLEUR | BURNER FINISH



HOUTCHIPS / CHIPS EN BOIS / WOODCHIPS



VERMICULITE / VERMICULITE / VERMICULITE



GRIJZE KEIEN / CAILLOUX GRIS / GREY PEBBLES



WITTE KEIEN / CAILLOUX BLANCS / WHITE PEBBLES

BINNENAFWERKING | FINITION INTÉRIEURE | INTERIOR FINISH
ORIGINAL

**BINNENAFWERKING | FINITION INTÉRIEURE | INTERIOR FINISH
DESIGN**

BINNENAFWERKING | FINITION INTÉRIEURE | INTERIOR FINISH
ROUND

BINNENAFWERKING | FINITION INTÉRIEURE | INTERIOR FINISH
TRIANGLE

CREDITS

p. 4

design by
PIETER VANRENTERGHEM
photography by
CAFEINE

p. 16

design by
PIETER VANRENTERGHEM
photography by
CAFEINE

p. 26

photography by
ANNICK VERNIMMEN
installation by
DE PUYDT HAARDEN

p. 36

design by
STUDIO DASKAL LAPERRE
photography by
BEELDCOLLECTIEF
installation by
DE PUYDT HAARDEN

p. 6

design by
PIETER VANRENTERGHEM
photography by
CAFEINE

p. 18

design by
MARC MERCX
GOVAERT & VANHOUTTE
ARCHITECTS
photography by
TIM VAN DE VELDE

p. 28

design by
CUBYC ARCHITECTS
photography by
CAFEINE
installation by
DE PUYDT HAARDEN

p. 37

design by
STUDIO DASKAL LAPERRE
photography by
BEELDCOLLECTIEF
installation by
DE PUYDT HAARDEN

p. 8

design by
AMTM
photography by
CAFEINE
installation by
LEFEBVRE HAARDEN

p. 20

design by
MARC CORBIAU
installation by
DE PUYDT HAARDEN

p. 30

design by
PIETER VANRENTERGHEM
photography by
CAFEINE

p. 40

design by
PASCAL FRANCOIS
photography by
CAFEINE
installation by
BOSMANS HAARDEN

p. 10

design by
MARIE LECLUYSE
photography by
CAFEINE
installation by
DE PUYDT HAARDEN

p. 22

design by
B-ARCHITECTEN
photography by
JAN VERLINDE
installation by
AMA HAARDEN

p. 32

design by
ATELIER 10.8
photography by
BERT DEMASURE
installation by
VINCKIER

p. 42

design by
THE CREATIVE COMPANY
photography by
CAFEINE
installation by
BOSMANS HAARDEN

p. 12

design by
PIETER VANRENTERGHEM
photography by
CAFEINE

p. 24

design by
B-ARCHITECTEN
photography by
JAN VERLINDE
installation by
AMA HAARDEN

p. 34

design by
YLAB
photography by
EUGENI PONS

p. 44

design by
FREDERIC KIELEMOES
photography by
CAFEINE

p. 46

design by
OBUMEX
photography by
ANNICK VERNIMMEN

p. 55

design by
STUDIO LEEMAN
photography by
CAFEINE
installation by
DE BACKER HAARDEN

p. 68

design by
YANNICK GOEGBEUR
photography by
ANNICK VERNIMMEN
installation by
DE PUYDT HAARDEN

p. 78

design by
PASCAL FRANCOIS
photography by
CAFEINE
installation by
BOSMANS HAARDEN

p. 88

design by
RR INTERIEUR x GRAIN D'OFFICE
photography by
CAFEINE
installation by
DE PUYDT HAARDEN

p. 48

design by
WENDY VERSTREPEN
photography by
PILAR SHOOTS
installation by
ROGER VAN DALE

p. 56

design by
BENOIT VIAENE
photography by
CAFEINE
installation by
BOSMANS HAARDEN

p. 70

design by
MARC CORBIAU
photography by
ANNICK VERNIMMEN
installation by
DE PUYDT HAARDEN

p. 80

design by
HANS VERSTUYFT
production & styling
MARC HELDENS
photography by
VERNE PHOTOGRAPHY

p. 98

design by
FILIP TACK DESIGN
photography by
CAFEINE
installation by
BOSMANS HAARDEN

p. 50

design by
ANNE-CATHERINE RAMBOUX
photography by
CAFEINE

p. 58

design by
MINUS
photography by
CAFEINE
installation by
LEFEBVRE HAARDEN

p. 72

design by
ATELIER DIALECT
photography by
CAFEINE
installation by
BOSMANS HAARDEN

p. 82

design by
PASCAL FRANCOIS
photography by
CAFEINE
installation by
BOSMANS HAARDEN

p. 52

design by
DIETER VANDER VELPEN
photography by
PATRICIA GOIJENS
installation by
AMA HAARDEN

p. 60

design by
STEVEN VAN COMPERNOL
photography by
ZOOMZONE
installation by
DE PUYDT HAARDEN

p. 74

design by
MARC CORBIAU
photography by
MIREILLE ROOBAERT
installation by
DE PUYDT HAARDEN

p. 84

design by
EGG ARCHITECTURE
interior styling by
BALO
photography by
CAFEINE
installation by
BOSMANS HAARDEN

p. 54

design by
MARIE LECLUYSE
photography by
CAFEINE
installation by
DE PUYDT HAARDEN

p. 62

design by
STUDIO LIV
photography by
PETER BAAS
installation by
BOXMAN VAN WIJK

p. 76

design by
HAARDEN
DE PLANCKE
photography by
KARIN COPPEJANS FOTOGRAFIE
installation by
HAARDEN
DE PLANCKE

p. 86

design by
GOVAERT & VANHOUTTE ARCHITECTS
photography by
TIM VAN DE VELDE

**Are your project
credits missing?**

**Please supply us
the names and
titles of the people
who created this so
we can add it to our
next print.**



RECOGNISE THE ORIGINAL

Metalfire+ BV
Noorwegenstraat 28
9940 Evergem-Belgium
+32 (0) 9 261 51 90

info@metalfire.eu
  metalfire.eu

**Architectural
Fire
Places**
Metalfire

MADE IN BELGIUM

Metalfire behoudt het recht specificaties te wijzigen zonder voorafgaand bericht
Metalfire se réserve le droit d'effectuer des modifications ou spécifications sans préavis
Metalfire preserves the right to modify specifications without previous notice - 2022